

cps®

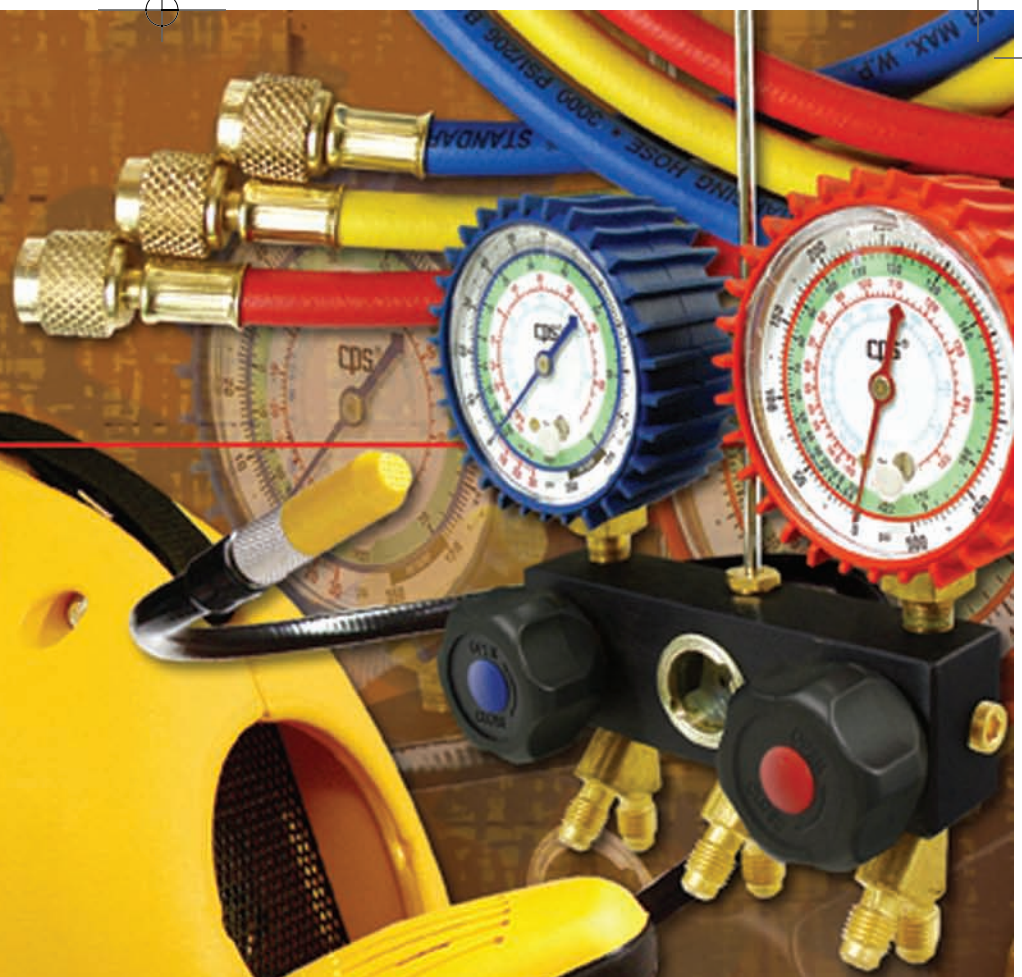

PROFESSIONAL AIR CONDITIONING & REFRIGERATION PRODUCTS





CPS®

CPS Products is a world leader in the design and manufacture of tools and test equipment used in the Automotive and HVACR industries. Founded in 1975, CPS has grown from a single employee and a single product to over 200 employees and 1200 products. CPS maintains 5 fully staffed subsidiary locations strategically located around the world. These global locations provide the loyal CPS customer base with unsurpassed service of our expansive product line. The success of CPS can be attributed to a basic philosophy of providing our customers with the very best our industry has to offer. This includes the best service, the best products and most importantly the best overall quality.

Supported by state-of-the-art mechanical and electronic manufacturing facilities, CPS is able to actively develop, maintain and continually improve our respected product lines in our wholly owned facilities. This ability is quite unique in today's rapidly changing manufacturing community providing CPS with a decisive edge when developing new innovative products that solve our customer's service needs. When one of our products becomes a trusted tool that a service professional will recommend to their friends, then our job is complete.

After all, we make our living by manufacturing the tools you rely on to make yours!

Worldwide Locations





TABLE OF CONTENTS

ELECTRONIC LEAK DETECTION 1 - 3



UV LEAK DETECTION 4 - 6



**CHARGING & RECOVERY SCALES/
CHARGING STATIONS** 7 - 9



**ELECTRICAL TEST & MEASURING
INSTRUMENTS** 10 - 11



**TEMPERATURE MEASUREMENT
INSTRUMENTS** 12 - 14



**VACUUM GAUGES
& SPECIALTY METERS** 15 - 16



PRO-SET® VACUUM PUMPS 17- 18



**PORTABLE RECOVERY / RECYCLING
EQUIPMENT** 19 - 22

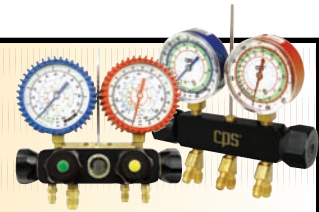



TABLE OF CONTENTS

SERVICE MANIFOLDS & GAUGES

23 - 30



GAS PRESSURE TEST KITS

31



VACUUM / CHARGING HOSES

32 - 34

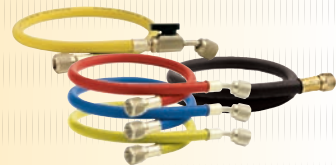

HOSE ADAPTERS / BALL VALVES / ANTI-BLOWBACK VALVES

35 - 36



VALVE CORE TOOLS

37



ACCESS FITTINGS

38



TUBING TOOLS

39 - 42



SPECIALTY HAND TOOLS

43 - 45





TABLE OF CONTENTS

AUTOMOTIVE SECTION



SERVICE MANIFOLDS & GAUGES **46 - 47**



CHARGING HOSES **48**



***R-134a COUPLERS / BALL VALVES
& ADAPTERS*** **49**



SPECIALTY HAND TOOLS **50 - 52**



UV LEAK DETECTION **53 - 55**



***ELECTRONIC TEST & MEASURING
INSTRUMENTS*** **56**



***MOBILE RECOVERY / RECYCLING /
RECHARGING EQUIPMENT*** **57 - 60**





ELECTRONIC REFRIGERANT LEAK DETECTION

THE ELIMINATOR™ LS3000B - Electronic Refrigerant Leak Detector



LS3000B

Fully automatic electronic refrigerant leak detector for all HFC, HCFC, CFC, SF6 gases & blends. Exclusive POWERSHIFT software automatically monitors, controls & adjusts all critical instrument settings to ensure maximum leak search results under any job environment. Two separate visual LED displays enable user to pinpoint the exact location of leak source & the approximate size of that leak.

SENSOR TYPE:	Cold Cathode Diode: Patented design allows fast, accurate detection of refrigerant leaks maintaining maximum sensitivity throughout the life of the sensor. Highly resistant to background contaminants including heavy condensation, oils, leak solutions, brake oils, radiator coolants, washer fluids, etc.
SENSITIVITY:	Fully automatic selection better than 0.10oz/yr (3g/yr) leak rate of HFC.
LEAK INDICATION:	Audible Alarms: Two user-selectable audible alarm options (HIGH and LOW intensity)
TACHOMETER DISPLAY:	Visual tachometer-like bar graph display: Eight high intensity LEDs
GEARSHIFT VISUAL DISPLAY:	Arranged in a gearshift pattern, 7 LEDs indicate the current sensitivity range of the unit and subsequent leak size
FLEX PROBE:	14" / 35.6cm long, 0.25"/6.4mm diameter
OPERATING TEMPERATURE:	0 to 140°F / -18 to 60°C
POWER:	75 hours battery life using three size "C" alkaline batteries. Auto OFF after 10 minutes of inactivity.
LOW BATTERY INDICATOR:	Right most LED on Tachometer display illuminates to indicate low battery condition.
WEIGHT:	1lb 2oz / 500g
WARRANTY:	2 years excluding sensors and batteries



A/C&R Application



Automotive Application



EXCLUSIVE POWERSHIFT™
Automatically controls all sensitivity related settings, eliminating guesswork and maximizing unit performance.

HIGHLY RESISTANT TO BACKGROUND CONTAMINANTS
Including heavy condensation, oils, leak solutions, brake fluid, radiator coolants, washer fluids, etc.

8 LED TACHOMETER DISPLAY
Enables user to pinpoint exact location of leak

EASY ONE BUTTON OPERATION
Depress once to turn unit ON.
Depress again to CLEAR the unit.
Double-click to change sensitivity.
Depress and hold to turn unit OFF.

STATE-OF-THE-ART COLD CATHODE DIODE (CCD) SENSOR TECHNOLOGY
Delivers quick response to leaks and maintains maximum sensitivity throughout the life of the sensor.

HIGH OUTPUT ALARM SPEAKER
Delivers clear crisp alarm tones

UNIQUE "GEARSHIFT" LED DISPLAY for LEAK SIZING
allows user to determine the approximate size of a leak.
Neutral - Unit is ready for operation
Leak Size: Small, Medium, Large





ELECTRONIC REFRIGERANT LEAK DETECTION

LEAK SEEKER® - LS780B / LS790B Electronic Refrigerant Leak Detectors



LS790B

Combines the most advanced microcomputer circuitry with field proven Ion-pump® sensor technology creating a highly sensitive, accurate electronic refrigerant leak detector. Over 100 computer generated tones and a high intensity bar graph display quickly alerts the user to varying halogen concentrations. Patented automatic calibration design eliminates the need for manual balance or tick rate adjustments while the user selectable 10 sensitivity ranges enables the **LS790B** to detect leaks of all refrigerants.

Specifications for the LS780B and LS790B

SENSOR TYPE:	Patented Ion-Pump® sensor with built-in selective filter housing
SENSITIVITY:	Better than 0.25oz/yr (7g/yr) leak rate of HFC.
AUDIBLE ALARMS:	Over 100 computer generated tones varying in intensity with leak size
VISUAL DISPLAY:	10 high intensity bar graph display (LS790B) / High intensity LED display (LS780B)
LOCK-OUT MODE:	Unique feature enables quick & easy locating of refrigerant leaks in highly contaminated search zones. In this mode, the unit will automatically & systematically store the recorded concentration levels of background refrigerant while initiating leak search, alarming only in the area of the highest recorded concentration level, the actual leak source. (LS790B only).
FLEX PROBE:	18" / 45.7cm long metal cable probe
OPERATING TEMP:	0 to 140F / -18 to 60C
POWER:	40 hours battery life using 4 "AA" alkaline batteries. Auto OFF after 15 minutes of inactivity.
LO BATT INDICATOR:	5th LED constantly illuminates dimly indicating low battery condition.
WEIGHT:	1lb 2oz / 500g
WARRANTY:	2 years (LS790B). 1 year (LS780B). Excludes sensors and batteries



LS780B

A rugged, three position slide switch is used to turn the instrument on & select either LO or HI sensitivity ranges. Visual indication of the leak size is provided by a high intensity LED varying in brightness with the concentration of the refrigerant detected.



Spare Parts for LEAK SEEKERS®



LSXS3



LSXBMK



LSXS

1= LS780A

2 = LS780B

3=LS790A

4=LS790B

5 = LS3000B

ITEM	PRODUCT	DESCRIPTION
LSXB	1,2,3,4	Battery compartment cover
LSXBMK	2,4	Maintenance Kit: (1)LSXS + (1)LSXSf
LSXC	1,2,3,4	Leather carrying case
LSXC3	5	Storage case LS3000
LSXE	1,2,3,4	Earphone
LSXMK	1,3	Maintenance kit • 2 pcs/St. LSXS + 2 pcs/St. LSXVF
LSXS3	5	Sensor for LS3000
LSXS	1,2,3,4	Ion-pump sensor
LSXSf	2,4	Selective filter/housing
LSXSH	1,3	Aluminum Sensor housing
LSXVF	1,3	Water vapor filter



ELECTRONIC REFRIGERANT LEAK DETECTION

Refrigerant Monitor



RM



Compact, highly reliable, yet economical refrigerant leak monitoring systems. Designed to monitor a single refrigerant in a single zone providing early warning of costly and environmentally damaging refrigerant leakage. Adjustable sensitivity settings between 100 to 1000PPM with an auxiliary 1/2 HP N.O. and N.C dry contact control function for operating an additional alarm or other safety device. Replacement sensors are interchangeable enabling the replacement of a failed sensor directly in the field without recalibration, minimizing "downtime."

Item No.	Refrigerant Type	Replacement Sensor
RM12	R-12	RMX12
RM134	R-134	RMX12
RMX11	R-22	RMX12
RM404	R-404A	RMX12
RM407	R-407	RMX11
RM410	R-410A	RMX12
RM502	R-502	RMX12
RM507	R-507	RMX12
Replacement Sensors		
RMX11	Replacement Sensor for Refrigerant Monitor	
RMX12	Replacement Sensor for Refrigerant Monitor	

SENSITIVITY:	100 to 1,000 ppm
ACCURACY:	± 3% of the setting or ± 25 ppm
VISUAL ALARMS:	High intensity LED display
AUDIBLE ALARM:	85 db at 1 foot
OPERATING TEMPERATURE:	-20 to 150 F / -28 to 65 C
SENSOR MODULE:	Relative Humidity 10 to 95% non-condensing
CONTROL MODULE:	32 to 150 F / 0 to 65 C
POWER:	AC or DC control voltages.
SENSOR FAILURE INDICATOR:	LED constantly illuminates
WEIGHT:	1lb 2oz / 500g
WARRANTY:	1 year

GAS SEEKER® GS30 - Portable Combustible Gas Detector

The **GS30** is a low maintenance, easy-to-use portable combustible gas leak detector engineered to pinpoint leaks in residential, commercial and industrial appliances. Advanced semiconductor sensor and electronic control package enables detection of gases commonly found in service applications including; Carbon Monoxide, Natural Gas, Propane, Ammonia, Methane, Acetone, Hydrogen and Iso-Butane, with a virtually instantaneous alarm response period. Measuring just over 7" long and 0.72" in diameter its compact tubular shape enables testing in limited access areas and conveniently fits into a serviceman's pocket. Applications include the inspection of furnaces, valves, regulators, pipelines, meters and other devices associated with combustible gases.



GS30

Gases Detected

Carbon Monoxide, Natural Gas, Propane, Ammonia, Methane, Acetone, Hydrogen, Iso-Butane Acetone, Acetylene, Benzene, Butane, Ethanol, Ethylene Oxide, Gasoline, Hexane, Industrial Solvents, Paint Thinners, and Naptha.

WARNING: THE GS30 IS NOT INTRINSICALLY SAFE IN CLASS 1 (EXPLOSIVE) TYPE ATMOSPHERES AND IS NOT SUITABLE FOR THE DETERMINATION OF HUMAN SAFETY OR HABITABILITY CONDITIONS.

Detecting Range	0 - 100% LEL referenced to Methane.
Alarm Indication	Both visual and audible (>40db) alarm indicators
Low Level Alarm	Preset at 10% LEL.
High Level Alarm	Preset at 30% LEL
Operating Conditions	0 °F to 104 °F / -20 °C to +40 °C at less than 98% RH (non-condensing)
Power	Working voltage is 3VDC using two 1.5V AA batteries.
Battery Life/Indicator	5 hrs continuous use. Orange LED constantly illuminates when battery is low
Sampling	Natural diffusion
Dimensions	7.2 x 0.71in / 183 x 18mm
Weight	5.3oz / 150g (including battery)



UV REFRIGERANT LEAK DETECTION

UVPRO UV Flashlight & Enhancing Glasses



Actual Size

UVPRO

Don't forget the "UV" when selecting your next UV light.

Ultra Violet (UV) dye additives are specially formulated to fluoresce in the presence of UV light rays. Hence the common industry names for the two major components used with this technology, "UV" dye and "UV" lights. Referring to the light spectrum chart below you can see that true "UV" light is invisible to the human eye, with the closest visible light colors being purple and blue respectively. The overall intensity of UV light diminishes as you move from the invisible UV light range to purple, then to blue and so on down the chart. Take care not to confuse a lamp that emits high intensity visible blue light as superior to a lamp tuned more efficiently to emit true UV light.

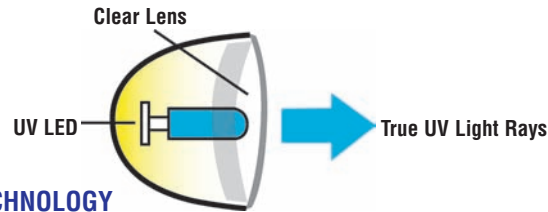

UV LED TECHNOLOGY

UV LED's produce only true and efficient UV Light. The CPS® UVPRO provides UV-A (Long wave UV) 325-375nm. Instant on LED provides the fastest leak inspection of any light available.

Light spectrum wavelengths in nanometers

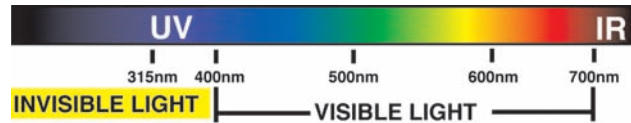

Why BLUE is NOT Necessarily Cool

A correctly tuned Ultra Violet (UV) lamp should predominantly emit invisible UV light waves with only a trace of visible "purple" or "blue" light. The small amount of visible light is required to direct the user's eyes to the leak search area, while the invisible UV light rays actually illuminate the leaking dye. Lamps that emit large amounts of visible blue light have been marketed heavily as being more powerful and more effective at fluorescing leaks, backed by the obvious high output of visible light. Knowing that UV dye additives requires invisible true UV light rays to effectively fluoresce dispels this claim altogether. In fact, special "blue blocking" glasses are required for use with these high output blue lamps in order to remove the nuisance blue light from the vision of the user during the leak search process. Otherwise, the high output of light will mask the actual leak or illuminating dye additive.

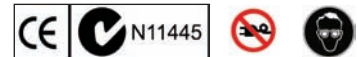

UVPRO - UV LED Light/Glasses Kit



UVPRO

The new and improved UVPRO light is the most compact and efficient UV light we have ever designed. The nine high intensity true UV LED's are specifically engineered to maximize the fluorescing capabilities of today's most commonly used dyes while greatly reducing the amount of "nuisance" background blue light emitted. Its rugged anodized aluminum body and o-ring sealed battery compartment allows it to handle harsh field conditions while small enough to conveniently fit in your pocket.

- 9 True UV emitting LED technology
- Rugged anodized aluminum body
- Works with all common dye additives
- Ultra Compact and lightweight
- Instant "ON" with no heat produced
- Operates on (3) AAA batteries (included)



UV REFRIGERANT LEAK DETECTION

UV55 LED Refrigerant Leak Detection Kit



UV55 Includes: UVPRO LED flashlight, squeeze gun injector w/ hose, R-134a 90° low coupler, safety glasses, UVS2 dye cartridge and carrying case.



UV55

- UVPRO True UV emitting LED light technology
- Compact & Rugged anodized aluminum body
- Mess-free and easy to use Squeeze Gun™ injector
- 1 UVS2 universal OEM approved dye cartridge
- Includes 90° low side snap coupler
- Operates 8 continuous hours on (3) AAA batteries (included)

UV Dichroic Refrigeration Leak Detection Kits



UV150

50W 12VDC dichroic filter lamp with 90° swivel head, rechargeable battery pack, 110V charger, Flow-thru injector, 1 oz universal dye, enhancing glasses and case

UV152: same as above w/220V Charger

UV152UN: includes UVSTICK2 injector/dye system instead of flow-thru type

UV200: same as listed above except with 8oz bottle of dye instead of 1 oz

UV250

50W 12VDC dichroic filter lamp with 90° swivel head, rechargeable battery pack, 110V charger, Squeeze Gun™ injector, 6 universal dye cartridges, enhancing glasses and case

UV252: same as above w/220V Charger

UV Dichroic Filter Lamps

UVCL

UVCL100



Powerful 50W Bulb
Instant On Technology
90° Swivel Head
Use with UVXB (not included)

Powerful 100W Bulb
Instant On Technology
45° Handle for Comfortable Grip
Use with UVXB (not included)

ACCESSORIES

UVXB	Rechargeable Battery Pack	UVXG	Safety/Enhancing Glasses
UVXBC	Battery Carrying Case	UVXLNS	50W Replacement Dichroic Lens
UVXC	100V Battery Charger	UVXLNS100	100W Replacement Dichroic Lens
UVXBLB	50W Bulb -UVAL/UVCL	UVXSGA	Hose Assembly for Squeeze-Gun Injector
UVXBLB100	100W Bulb- UVAM/UVCL100	UVXSH	Hose Assembly for UVSTICK1
UVXBLBPRO	Replacement Bulb for UVPRO before 2007	UVXSHA	Hose Assembly for UVSTICK2 and Lo Coupler
UVXC	110V Battery Charger	UVXSTA	3/8" FM X LO side Auto Adapter for UVSTICK
UVXCE	220-240v Battery Charger		
UVXCN	Battery Connectors		



UV REFRIGERANT LEAK DETECTION

Prefilled/Disposable Refrigerant Dye Capsules & Cartridges

- Universal OEM approved dye formula
- Cleanest, easiest & fastest method of injection
- No refrigerant required to inject dye
- 4 sizes to match capacity of system
- Eliminates air entering system
- Eliminates over-injection of dye



all dyes include I.D. labels...



SYSTEM TYPE	REFRIGERANT CHARGE	REFRIGERANT OIL	DYE CAPSULE STICK qty.6	SQUEEZE CARTRIDGES qty.6
SMALL Ice machines, window A/C units, autos, refrigerators	Up to 2.9 lbs. Up to 1.3 kg	Up to 15 fl. oz. Up to .44 liter	UV101 	UVS101
MEDIUM Residential Systems	3 to 4.9 lbs. 1.4 to 2.2 kg	16 fl. oz. to 1.6 qt. .45 to 1.8 liters	UV1 	UVS1
MEDIUM-LARGE Light commercial and large residential systems	5 to 9.9 lbs. 2.3 to 4.5 kg	1.7 qt. to 3.2 qt. 1.9 to 3.7 liters	UV2 	UVS2
LARGE Commercial and light industrial, including all split systems	10 to 25 lbs. 4.6 to 11.4 kg	3.3 qt. to 2 gal. 3.8 to 9.1 liters	UV3 	UVS3

In-line capsules are only for use with Spectronics® & Tracer® products' dye injection kits, bleed valves and universal connect sets

Bottled Refrigerant Dyes



UVUD6

- 8oz/237ml Universal dye bottles (6 per case)
- Universal - works with PAG, Ester and mineral oils
- Lowest cost per application
- Excellent for large systems

APPLICATIONS

Automotive: 1/4oz / 7.5ml per vehicle (32 vehicles per bottle)
A/C&R: 1/4oz / 7.5ml per 20oz/591ml of systems lubricants

All MOONSHINE™ dye meets SAE J2297 standard. Spectronics™ & Tracer are all registered trademarks of the respective company



UVUDS

- 1oz/ 30ml Universal dye bottles (6 per case)
- Universal - works with PAG, Ester and mineral oils

Applications:

Automotive: 1/4oz / 7.5ml per vehicle (4 vehicles per bottle)

Refillable Expandable - 1/4oz. / 7.5ml to 2oz. / 60ml Capacity



UVNJ
In-Line AC&R 1/4"
1/4 to 1/2oz. - 7.5 to 14ml



TLJ2 R-12 1/4" SAE Oil Dye Injector
TLJ4 R-134a 1/2" Acme Oil Dye Injector

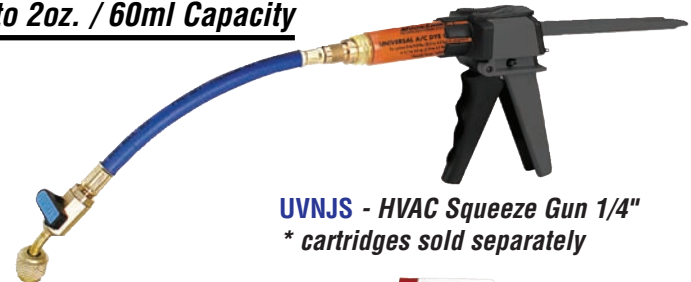

UVNJS - HVAC Squeeze Gun 1/4"
* cartridges sold separately

STEP 1: LOAD CARTRIDGE

STEP 2: ATTACH HOSE

STEP 3: CONNECT & INJECT

STEP 4: CLEAN PORT & DISCARD EMPTY CARTRIDGE



UVCLNR
32oz./946ml. dye cleaner



REFRIGERANT CHARGING / RECOVERY SCALES

CC220 COMPUTE-A-CHARGE® High Capacity Charging Scale



High capacity 220lb/100kg Compute-A-Charge® refrigerant charging/recovery scale, calibrated to strict NIST standards. Fully enclosed and removable metal scale platform enables use of product in or out of the protective case. Large, highly visible 1 1/2" x 2"/37mm x 48mm high resolution LCD readout displays either Imperial or Metric measurements in .25oz / 10g increments. The ergonomic hand held remote incorporates 6ft coil cord, a hanging hook and is backed with a magnet for attaching to metal surfaces. Full mechanical and visual overload protection. Operates 60 continuous hours on two 9V alkaline batteries. Includes automatic off feature.

CERTIFIED
CALIBRATED TO STANDARDS TRACEABLE TO THE NATIONAL INSTITUTE OF STANDARDS AND TECHNOLOGY (N.I.S.T.)



CARRYING CASE
10 3/4" X 13 1/2" X 2 1/2"

CAPACITY	220LB /100Kg
ACCURACY	.015% of Reading
RESOLUTION	±1/4oz /±10g
PLATFORM SIZE	8 3/4" x 8 3/4" 223 x 223mm Removable
WEIGHT	5.6 lb/2.55 kg
POWER	(2) 9V battery included. Operates 60 cont. hours
READOUT	Imperial /Metric
OPERATING TEMP	-4°F - 156°F / -10°C to 50°C
PROGRAMMABLE	No

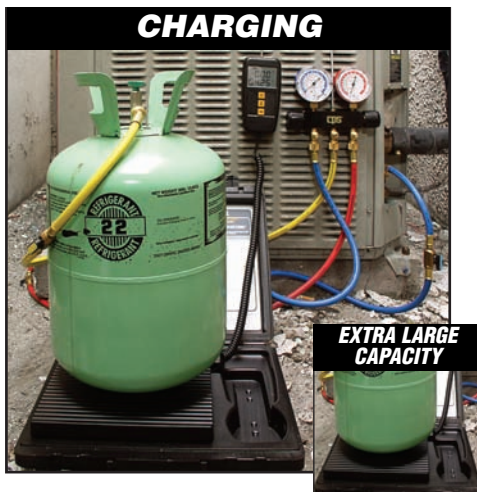

CHARGING

EXTRA LARGE CAPACITY



HEATER BLANKET

CHARGE FASTER IN COLD WEATHER!

CCXHB - 110 VAC / 340W / 150°F
CCXHBV - 220 VAC / 340W / 65°C



RECOVERY



REFRIGERANT CHARGING / RECOVERY SCALES

Programmable High Capacity Charging Scale



CC800A

Programmable high capacity 220lb/100kg Compute-A-Charge® refrigerant charging/recovery scale, calibrated to strict NIST standards. Operating exclusively on two 9V alkaline batteries, the CC800A is the only fully automatic refrigerant scale that does not require line voltage and is R-410A compatible. Using the keypad controls, simply program the CC800A to transfer or recover a pre-set amount of refrigerant, hit “go” and walk away. The scale’s advanced microcomputer circuitry will constantly monitor the progress of the job, shutting off the refrigerant flow when the pre-set amount is reached and audibly alert the user. A large, highly visible 1 1/2" x 2" / 37mm x 48mm high resolution LCD readout displays either Imperial or Metric measurements in .25oz / 10g increments. The ergonomic hand held remote incorporates a 6ft coil cord, a hanging hook and is backed with a magnet for attachment to metal surfaces. Full mechanical and visual overload protection. Operates 30 continuous hours on two 9V alkaline batteries. Automatic off feature.



CAPACITY:	220LB / 100Kg
ACCURACY:	.015% of Reading
RESOLUTION:	±1/4oz / ±10g
PLATFORM SIZE:	8 3/4" x 8 3/4" 223 x 223mm Stationary

WEIGHT:	8.5 lb/3.9 kg
POWER:	(2) 9V batteries included
READOUT:	Imperial /Metric
OPERATING TEMP:	-4°F - 156°F / -10°C to 50°C
PROGRAMMABLE:	Yes

Legal For Trade Charging Scale



CCLT

Certified by NMI to meet or exceed OIML standards. Adjustable feet and bubble level ensure accurate weight measurements. The ergonomic hand held remote incorporates a 6ft coil cord, a hanging hook and is backed with a magnet for attaching to metal surfaces. Full mechanical and visual overload protection. Operates 60 continuous hours on two 9V alkaline batteries.

CAPACITY:	50 Kg
ACCURACY:	Class III
RESOLUTION:	20 g
PLATFORM SIZE:	8 3/4" x 8 3/4" 223 x 223mm Removable
WEIGHT:	5.6 lb/2.55 kg
POWER:	(2) 9V battery included
READOUT:	Metric Only
OPERATING TEMP:	-4°F - 156°F / -10°C to 50°C
PROGRAMMABLE:	No



REMOVABLE PLATFORM



Bubble Level

Bubble Level
ensures accurate
weight measurements

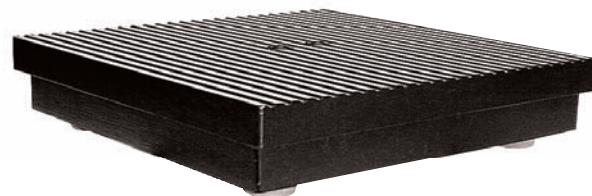

CPS®

PRO-SET®

REFRIGERANT CHARGING / RECOVERY SCALES

PRO-SET® Portable Vacuum/Charging Stations

“Ideal for both new installations and existing service work.”

PRO-SET® charging stations combine all the necessary tools required to perform a full system evacuation and subsequent charging in a single, compact, mobile unit. Each station includes a Vortech or BlackMax service manifold, a PRO-SET® vacuum pump, a Compute-A-Charge® refrigerant scale and premium charging hoses. The lightweight tubular steel frame incorporates rear wheels for easy transport to and from the jobsite with integrated storage areas for all components.

- Unsurpassed Charging Accuracy of $\pm 0.015\%$ of reading
- Hanging ports and hooks for hose storage
- Rear wheels on Frame for Ease of Mobility
- Contains all Tools Needed for Charging / Evacuation
- All Components Store Easily on Cart



CS12DMV5JP5E



MV5JD



HP6



VP2D



CC220

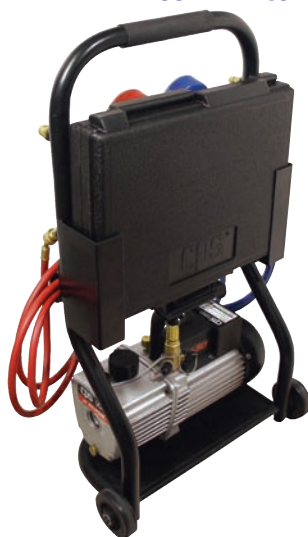

Hard mounted manifolds

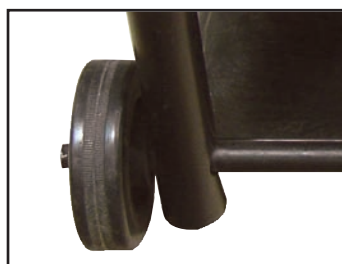

Rear wheels on Frame for Ease of Mobility

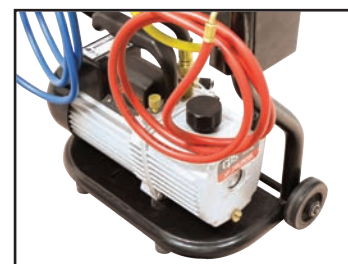

All Components Store Easily on Cart

Item	Application	Manifold Type	Refrig. Scales	Press. / Temp. Scales	Hoses	Vacuum Pump	Scale
CS12DMV4JP5E	Appliance / Light Refrigeration	Vortech 4 Valve (MV4J)	R22, R134A, R404A, R407C (80mm)	BAR/PSI °C	3-pk of 150cm Prem. BV Hoses	Two Stage 45 l/m Pump (15 microns)	100kg Compute-A-Charge Scale
CS12DMV5JP5E	Air Conditioning	Vortech 5 Valve (MV5JD)	R22, R134A, R404A, R407C (80mm)	BAR/PSI °C	3-pk of 150cm Prem. BV Hoses	Two Stage 45 l/m Pump (15 microns)	100kg Compute-A-Charge Scale
CS12DMV5J3P5E	Air Conditioning / Refrigeration	Vortech 5 Valve (MV5J3D)	R22, R134A, R404A, R407C (80mm Oil Filled)	BAR/PSI °C	3-pk of 150cm Prem. BV Hoses	Two Stage 45 l/m Pump (15 microns)	100kg Compute-A-Charge Scale
CS12DMV1202J5E	Air Conditioning / Refrigeration	Vortech 4 Valve (MV12O2)	R410A, R22, R407C (80 mm)	BAR/PSI °C	3-pk of 150cm Prem. BV Hoses	Two Stage 45 l/m Pump (15 microns)	100kg Compute-A-Charge Scale
CS12DMV5WS10Q	Air Conditioning / Refrigeration	Vortech 5 Valve (MV5WD)	R134A, R404A, R407C, R507 (80 mm Class 1)	BAR °C Class 1	3-pk of 300cm Standard Hoses & R134a Couplers	Two Stage 45 l/m Pump (15 microns)	100kg Compute-A-Charge Scale
CS12DMV4HCP5E	Air Conditioning / Refrigeration	Vortech 4 Valve (MV4HC)	R600a, R290 (68mm)	BAR/PSI °C	3-pk of 150cm Prem. BV Hoses	Two Stage 45 l/m Pump (15 microns)	100kg Compute-A-Charge Scale
CS12DMV5HCP5E	Air Conditioning / Refrigeration	Vortech 5 Valve (MV5HCD)	R600a, R290 (68mm)	BAR/PSI °C	3-pk of 150cm Prem. BV Hoses	Two Stage 45 l/m Pump (15 microns)	100kg Compute-A-Charge Scale



ELECTRICAL TEST & MEASURING INSTRUMENTS

True RMS Digital Clamp-On Meter - CAT III 600V



AC650

- Display: 4 digit large character LCD
- Versatile for testing AC/DC voltage, AC/DC current, resistance and frequency
- True RMS AC measurement
- Data hold
- Max./Min. value measurement
- Clamp light and LCD backlight
- Auto zero key for DCA measurement
- Auto/Manual range, auto power off
- Secondary injection molded case, safety as per IEC1010 CAT.III 600V
- 40Hz - 100kHz (from test leads), +/- 0.1%
- 40Hz - 400Hz (from clamp jaw), +/- 0.1%
- DCV: 4 / 40 / 400 ± 0.8% 1000V ± 1%
- ACV: 4/40 / 400/ 700V, +/- 1.2%
- DCA: 400 /600 / 1000A ±3%
- ACA: 400 / 600 / ± 2.5%, 600/1000A ±3%
- OHM: 400 /4k / 40k / 400k/4MΩ / 40MΩ ± 2%
- Audible continuity and diode test
- Clamp size: 42mm (max.)
- Battery: 3 x 1.5V AAA
- Dimensions and weight: 225 x 86 x 33mm, 320g
- Accessories: Test Leads and Carrying Pouch



AC650 Replacement Parts

DMXTL 1000V Cat 3 Test Leads



Open-Jaw Digital Electrical Meter - CAT III 600V



AC450

- Display: 4 digit large character LCD
- Auto/manual range
- Relative, data hold, backlight
- Auto power off
- DCV: 4 /40 /400V ±0.7% 100V ± 0.8%
- ACV: 4 /40 / 400V ±0.8% 700V ± 1.0%
- ACA: 200A ±3.0% (50Hz to 1000Hz)
- 400 /4k / 40k / 400k /4M Ω ±1.2%
40M ±2.0%
- CAP: 40n/400n/4μF ±4.0%
- Frequency: 10Hz to 100kHz ±2.0%
- Duty Cycle: 0.1% to 99.9%
- Continuity test - audible
- Diode test
- IEC1010 standard
- Accessories: Test Leads and Carrying Pouch
- Battery: 9V (1)

AC450 Replacement Parts

DMXTL 1000V Cat 3 Test Leads





ELECTRICAL TEST & MEASURING INSTRUMENTS

Digital Multimeter - CAT III 1000V



- RS-232 interface
- Designed to international safety standard IEC1010 CAT.III 1000V
- Secondary molded case
- Display: 4 digit large character LCD
- DC Voltage: 60m/6/60/600V ± 0.5%, 1000V ± 0.8%
- AC Voltage: 60m/6/60/600V ± 0.8%, 700V ± 1.0%
- DC Current: 600µ/6000µ/60m/600mA ± 1.2%, 10A ± 1.5%
- AC Current: 600µ/6000µ/60m/600mA ± 1.5%, 10A ± 2.0%
- Resistance: 600/6k/60k/600k/6MΩ ± 1.0%, 60MΩ ± 1.5%
- Capacitance: 6nF ± 1.8%, 60n/600n/ 6µ F ± 1.0%, 60µ/600µ/6mF ± 1.5%
- Frequency: 6000/60k/600k/6M/60MHz ± 0.5%
- Diode Test
- Continuity Test - audible
- Autorange and Manual Range
- Data Hold
- Max./Min. Value Measurement
- Back Light
- Auto Power Off
- One 9V Alkaline battery
- Size: 195 x 92 x 43mm
- Weight: Approx. 380g (including battery)
- Accessories: Hard carrying case, Test leads, "K" type bead Thermocouple, and Data log application software & RS232 cable
- Temperature: -40°C to 500°C ± 2%

DM450



DM450 Replacement Parts

DMXTL	1000V Cat 3 Test Leads
DMXF2	Fuse Set



Autorange Digital Multimeter - CAT III 600V

- Designed to international safety standard IEC1010 CAT III 600V
- Secondary injection molded case
- Auto Range
- Data Hold
- Maximum Value Measurement
- Back Light
- Auto Power off
- Display: 4 digit large character LCD
- DC Voltage: 200m / 2 / 20 / 200 / 600V ±0.7%
- AC Voltage: 200m / 2 / 20 / 200 / 600V ±0.7%
- DC Current: 200µ / 2000 µ / 20m / 200mA ±1.2%, 2/10A±2.0%
- AC Current: 200 µ / 2000 µ / 20m / 200mA ±1.5%, 2/10A±3.0%
- DC Current: (WITH OPTIONAL CLAMP): 200/2000A (0.1mV/0.1A) ±1.2%
- AC Current: (WITH OPTIONAL CLAMP): 200/2000A (0.1mV/0.1A) ±1.5%
- Resistance: 200 / 2k / 20k / 200k / 2M ± 1.2%: 20M ± 2.0%
- Temperature: -20°C - 1000°C ± 3.0%, 0°F ~ 1800°F ± 3.0%
- Capacitance: 20n / 200n / 2µ / 20µ / 200µ / 2000µF ± 4.0%
- Continuity Test - Audible
- Diode Test
- Transistor hFE Test
- Power: 1.5V (AAA) X 3
- Size: 158 X 74 X 31mm
- Weight: Approx. 220g (INCLUDING BATTERY)
- Accessories: Thermocouple, Leads, and Batteries

DM350



DM350 Replacement Parts

DMXTL	1000V Cat 3 Test Leads
DMXF1	Fuse Set



TEMPERATURE MEASUREMENT INSTRUMENTS

TEMP-SEEKER® Four-Port Digital Thermometers



TM250/TM250C

Professional grade temperature measurement instrument with four remote stations and a wide range of job specific accessory probes to complete all your temperature testing needs. Measures temperature differential between any two of the four remote stations and incorporate unique SCAN function that alternates measurement readings between all four of its remote stations in three-second intervals. Upgradeable to measure relative humidity, dewpoint and drybulb using the TMX2RH accessory probe. Incorporates Min/Max, Memory, °F/°C and Clear functions.

TM250 includes (1) TMX2A, (1) TMX2G, (1) TMX2S
TM250C includes (1) TMX2A, (1) TMX2S, (1) TMX2C



Incorporates Min/Max, Memory, °F/°C and Clear functions

Probes for TM250/TM250C Series

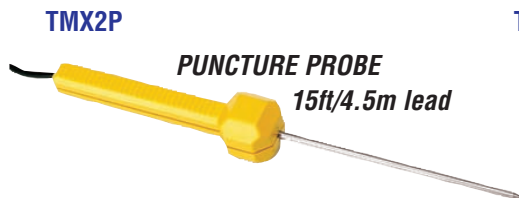

JOB SPECIFIC PROBES FOR ALL OF YOUR TEMPERATURE TESTING NEEDS



TMX2RH
 Drybulb/Dewpoint probe TM250 15ft/4.5m lead
 RELATIVE HUMIDTY

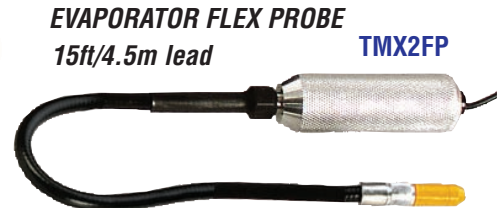



TEMPERATURE MEASUREMENT INSTRUMENTS

TEMP-SEEKER® Non-Contact Infrared Thermometer



The **TMINI12** infrared thermometer provides instant temperature measurement over a wide range of applications. The unit offers simple one-handed operation, laser point sighting, a backlit display, °C/°F select ability and an automatic power off feature. Use the TMINI12 to quickly measure temperatures of registers, ductwork, furnaces, evaporators, condensers, compressors, relays, manifolds, radiators, exhaust systems, thermostats, bearings and more. Leather carrying case and 9V alkaline battery are included.

TEMPERATURE RANGE:	-76°F to 932°F or -60°C to 500°C
D:S (Distance to Spot Size):	12:1
EMISSIVITY:	Emmissivity pre-set at 0.95 - adjustable
ACCURACY:	±2°C (±4°F) or ±2% of reading
DISPLAY:	Digital Backlit LCD
RESOLUTION:	1°C/°F
BATTERIES/LIFE:	(2) AAA batteries and auto power off



The unit offers simple one-handed operation, laser point sighting, a backlit display, °C/°F select ability and an automatic power off feature.

Digital and Analog Pocket Thermometers



TM50

Digital pocket thermometer with stainless steel probe and pocket clip.
Range: -58° to 302°F / -50° to 150°C

A step above the standard pocket thermometer the **TM50** is packed full of features, including a user selectable temperature alarm, a countdown timer, Min/Max, °F/°C selectable and memory functions. The unit incorporates a highly accurate stainless steel 96mm puncture probe with a 4ft/122cm cord. Temperature range is -58° to 500°F / -50° to 260°C. The TM50 operates on a single AAA alkaline battery with 25 hours of battery life and a low battery indicator.

TMAP

Analog pocket thermometer with 1" dial and Stainless steel probe and pocket clip
TMAP: Range: 0° to 220°F
TMAPC: Range: -40° to 80°C

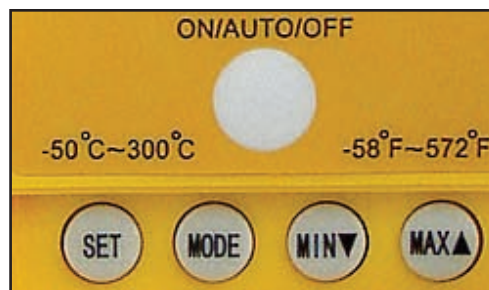

TM50

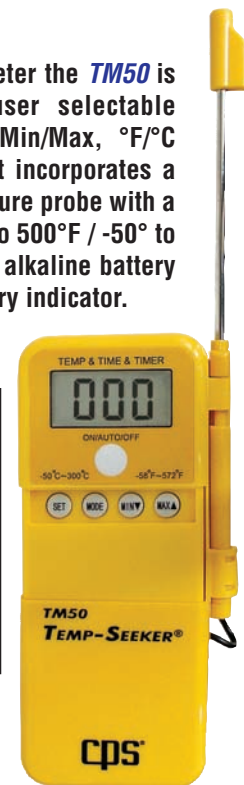



TEMPERATURE MEASUREMENT INSTRUMENTS

K-TYPE TEMPERATURE PROBES



TMXSK90
Max Temp: 752°F (400°C)

The **TMXSK90** is the fastest and most accurate handheld K-type surface probe providing accurate readings in less than 5 seconds. The sensor is made from flat-spring ribbons of thermocouple material for contact on uneven surfaces. An angled head for measuring hard to reach surfaces and a 3 foot coiled lead for durability and long reach. The exposed junction provides for fast response and is compatible with any other instrument with a **K-Type** input.

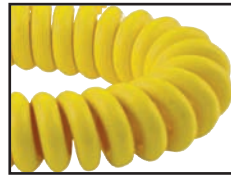

Coiled Lead



Flat-Spring Ribbons



Angled Head

The **TMXSK** is the fastest and most accurate handheld K-type surface probe providing accurate readings in less than 5 seconds. The sensor is made from flat-spring ribbons of thermocouple material for contact on uneven surfaces. A ribbed handle for grip and a 3 foot coiled lead for durability and long reach. The exposed junction provides for fast response and is compatible with any other instrument with a **K-Type** input.

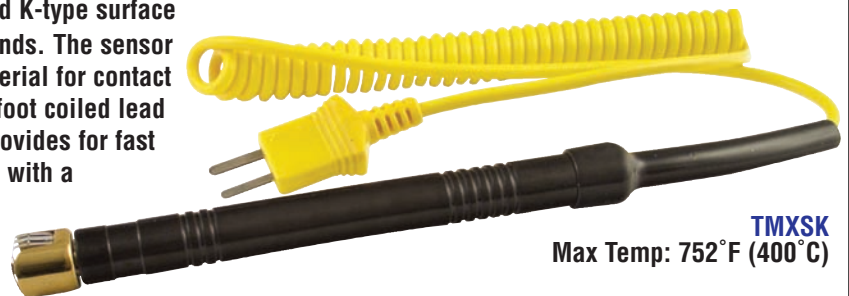

TMXSK
Max Temp: 752°F (400°C)

Used as seen above on the **CPS TMINI12** and is compatible with any other instrument with a **K Type** input.



TMINI12

TMXSK

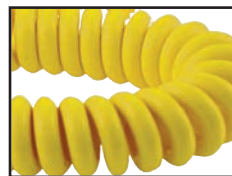

Coiled Lead



Flat-Spring Ribbons



Ribbed Handle

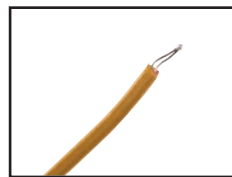

Bead

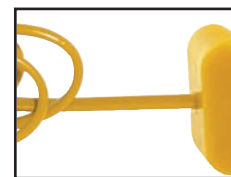

Covered Lead

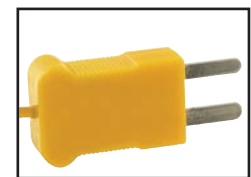

Exposed Junction

The **TMXKBEAD** is a standard K-type bead probe ideally suited for getting fast results when measuring temperature in a variety of media. This 36" long (1 meter) probe provides accurate readings in less than 5 seconds over the range of -58°F to 400 °F (-50 °C to 204 °C).



TMXKBEAD
Max Temp: 400°F (204°C)
Min Temp: -58°F (-50°C)



ELECTRONIC GAUGES & METERS

VACROMETER™ Digital Vacuum Gauge



VG200

AVT45

Advanced measurement instrument providing continual digital readout of evacuation process on large 5 digit LCD. Measurement units are user selectable to read in Microns, Torr, in/hg or mBar at the touch of a key. Advanced surface mount technology automatically compensates for ambient changes in the environment ensuring accuracy and consistency in performance. Advanced field-cleanable sensor is able to withstand 400 PSI of positive pressure. Unit operates 30 hours on 9V alkaline battery with low battery indicator and auto off feature. Includes carrying case, hanging hook, AVT45, 9V battery and is CE approved.

VG201 = VG200 + 1/8" NPT Thread Connection



SENSOR:

TYPE	Self - heated thermistor bridge with integral temperature compensation from 0 to 50 °C (32 to 122 °F).
OPERATING PRESSURE RANGE	Atmospheric pressure to 0 microns Maximum Working pressure: 400 PSIG
BURST PRESSURE	3000 PSIG
OPERATING RANGE	VG200- Atmospheric to 0 microns / VG100A- Atmospheric to 25 Microns
ACCURACY	+/- 10% of Reading.
OPERATING TEMPERATURE RANGE	Compensated (accuracy as stated): 0°C TO 50°C (32°F TO 122°F) Non-compensated (add +/- 0.5% error for every °C outside compensated range): 0 to 50°C (-22 to 158°F)
OPERATING & STORAGE HUMIDITY	0-95%, non-condensing.
STORAGE TEMPERATURE	- 40 to 185°F / - 40 to 85°C
POWER SOURCE	One 9 volt alkaline battery (ANSI 1604AC – IEC 6LR61)
BATTERY LIFE	20 hours of continuous use. Instrument shuts itself off after 5 minutes of operation.
WEIGHT	5.5 oz. / 153 g. excluding the battery.
DIMENSIONS	68 mm. diameter by 40 mm. deep by 124 mm. overall height (2.7" dia. by 1.6" deep by 5" overall height).
MECHANICAL CONNECTION	Standard 1/4" female SAE refrigerant hose type with core depressor.
BATTERY INDICATOR	Battery symbol with 3 segment Power Level Bar Graph. (VG200). LED Low Battery Indicator (VG100)

VACROMETER™ Vacuum Gauge



VG100A

AVT45

1/4" SAE Female x
1/4" SAE Male

Compact self-contained instrument designed to provide constant indication and monitoring of the evacuation process from start to finish. Nine discrete high intensity LED's are preset to illuminate upon achieving industry standards for proper system evacuations. Advanced surface mount technology automatically compensates for ambient changes in the environment ensuring accuracy and consistency in performance. Advanced field-cleanable sensor is able to withstand 400 PSI of positive pressure. Unit operates 25 hours on 9V alkaline battery with low battery indicator and auto-off feature. Includes carrying case.



Spare parts & Accessories for VG100A / VG200

ITEM	DESCRIPTION
VGXC	Carrying case VG100A/ VG200
VGXH	Hanging Hook
AVT87	Adapter for VG100A/VG200. 1/4" SAE male to 1/2"-20 male to 1/2" -20 swivel female tee
AVT48	Adapter for VG100A/VG200. 1/4" SAE male to 1/2" ACME male to 1/4" SAE swivel female tee
AVT45	Adapter for VG100A/VG200. 1/4" SAE male to 1/4" SAE male to 1/4" SAE swivel female tee

cps®

PRO-SET®

VACUUM PUMPS

Dual Voltage Two Stage Vacuum Pumps

DUAL VOLTAGE



GAS BALLAST VALVE

LARGE OIL SIGHTGLASS



Dual voltage design vacuum pump operates on 115 VAC or 230 VAC (50 or 60Hz). Advanced two-stage design pulls deep vacuum fast to 15 microns.

Model	VP2D	VP3D	VP6D
Free Air Displacement	1.9 CFM @ 60HZ 45 l/m @ 50Hz	3.15 CFM @ 60HZ 75 l/m @ 50Hz	6.25 CFM @ 60HZ 148 l/m @ 50Hz
Horse Power RPM (50/60Hz)	1/4 HP 1440/1720	1/3 HP 1440/1720	1/2 HP 2880/3440
Ultimate Vacuum	15 microns		
Inlet Ports (male flare)	1/4", 3/8" SAE Male & 1/2" ACME Male		
Oil Capacity	12oz./350 ml	15oz./450ml	15oz./ 450ml
Dimensions	13" x 5.3" x 10"	13.7" x 5.6" x 10.4"	13.7" x 5.6" x 10.4"
Shipping Weight	21.66lb/9.8kg	25.42 lb/11.5kg	25.42lb/11.5kg

For Australia: VP2DA, VP3DA, VP6DA all Single Voltage 240VAC/50Hz.



Universal IEC plug
All units/dual voltage 115V & 230V

Model	VP8D	VP10D	VP12D
Free Air Displacement	7.9 CFM @ 60HZ 186 l/m @ 50Hz	10.0 CFM @ 60HZ 236 l/m @ 50Hz	11.8 CFM @ 60HZ 278 l/m @ 50Hz
Horse Power RPM (50/60Hz)	2/3 HP 2880/3440	2/3 HP 2880/3440	3/4 HP 2880/3440
Ultimate Vacuum	15 microns		
Inlet Ports (male flare)	1/4", 3/8" SAE Male & 1/2" SAE Male		
Oil Capacity	13.5 oz./400ml	14 oz./425ml	15 oz./450ml
Dimensions	15" x 6.2" x 11.2"		
Shipping Weight	32.95lb/14.5kg	34.26lb/15.5kg	36.47lb/16.5kg

Dual Voltage Single Stage Vacuum Pumps

DUAL VOLTAGE

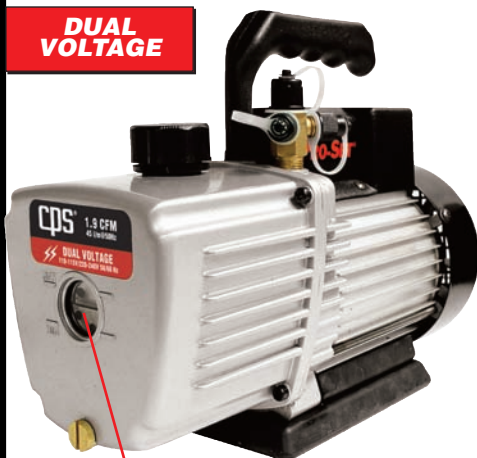

LARGE OIL SIGHTGLASS



Model	VP2S	VP3S	VP6S
Free Air Displacement	1.9 CFM @ 60HZ 45 l/m @ 50Hz	3.15 CFM @ 60HZ 75 l/m @ 50Hz	5.85 CFM @ 60HZ 138 l/m @ 50Hz
Horse Power RPM (50/60Hz)	1/5 HP 1440/1720	1/4 HP 1440/1720	1/3 HP 1440/1720
Ultimate Vacuum	100 microns		
Inlet Ports (male flare)	1/4", 3/8" SAE Male & 1/2" ACME Male		
Oil Capacity	13.5 oz./400 ml	13 oz./380 ml	17 oz./ 500 ml
Dimensions	13" x 5.3" x 10"	13" x 5.3" x 10"	13.7" x 5.6" x 10.4"
Shipping Weight	18.11lb/8.2kg	19.44lb/8.8kg	24.75lb/11.2kg

VPXJ220
220 VAC jumper power cord for locations where 110 voltage is not available.



VPXOMP
Oil mist preventer exhaust port.

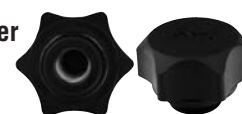



PRO-SET®

VACUUM PUMPS

Vacuum Pump Replacement Parts

ITEM	DESCRIPTION
VPXB2	Rubber Base-Medium VP6S/VP6D
VPXB3	Rubber Base- Large VP8D/VP10D/VP12D
VPXC100	Capacitor 100ufd VP6S/VP6DVP8D/VP10D/VP12D
VPXCS2	Centrifugal motor start switch (PCB) VP6S/VP6D
VPXCS3	Centrifugal motor start switch (PCB) VP8D/VP10D/VP12D
VPXEB2	End Bell w/Sightglass (Medium) VP6S/VP6D
VPXEB3	End Bell w/Sightglass (Large) VP8D/VP10D/VP12D
VPXEB02	End Bell O-ring (Medium) VP6S/VP6D
VPXEB03	End Bell O-ring (Large) VP8D/VP10D/VP12D
VPXEH	Plastic Electric Housing- VP6S/VP6DVP8D/VP10D/VP12D
VPXEP1	Electrical Panel VP6S/VP6D
VPXEP2	Electrical Panel VP8D/VP10D/VP12D

ITEM	DESCRIPTION
VPXF15	Fuse T15A VP8D/VP10D/VP12D
VPXFB2	Fan Blade- Medium VP6S/VP6D
VPXFB3	Fan Blade- Large VP8D/VP10D/VP12D
VPXFG2	Fan Grill- Medium VP6S/VP6D
VPXIP3	Port Kit 8-12 CFM VP8D/VP10D/VP12D
VPXODP	Oil Drain Plug w/O-ring VP6S/VP6D/VP8D/VP10D/VP12D
VPXOEP	Exhaust/Oil Fill Port VP6S/VP6D/VP8D/VP10D/VP12D
VPXOL2	Overload B120-110 DRB4 VP6S
VPXOL3	Overload DF690-KB DRB3
VPXH	Handle VP6S/ VP6D VP8D/VP10D/VP12D
VPXIP2	Port Kit 2-6 CFM VP6D

Anti-Siphon Valve Kits



VPASU



VPAS8

VPAS4 - 1/4" SAE Female Knurl Nut
VPAS8 - 3/8" SAE Female Knurl Nut
VPASU - 1/4" SAE, 3/8" SAE, 1/2"-20 UNF Female Knurl Nut

The CPS anti-siphon valve is an essential accessory to any vacuum pump application. The anti-siphon valve prevents the cross-contamination of vacuum pump oil and the compressor oil in the A/C or refrigeration system being serviced. Mixing of vacuum pump oil and compressor oil can cause premature failure in the A/C or refrigeration system. CPS makes three models that fit all CPS and other brands of vacuum pumps. *Add to any brand of vacuum pump to prevent the cross-contamination of vacuum pump oil and the compressor oil of the system being serviced.*



Connects directly to intake port of pump.
All kits includes:
 1/4" SAE, 3/8" SAE & 1/2"-20 UNF Male fittings.

Premium Vacuum Pump Oils



PRO-SET® Premium Vacuum Pump Oil is an extremely high quality, severely hydrotreated vacuum pump oil. The oil is compatible for use in pumps made by most manufacturers. **PRO-SET® Premium Vacuum Pump Oil** should always be clean and free of contaminants such as moisture, acids, vapors, dirt etc. It is strongly recommended that the vacuum pump oil be changed after each use to improve service and the life of the pump.

VPOG 6
one gallon/qty.6

VPOQ 12
one quart/qty.12

VPOP 12
one pint/qty.12

ITEM	DESCRIPTION
VPOG6	(6) one gallon bottles
VPOQ12	(12) one quart bottles
VPOP12	(12) one pint bottles

Vacuum Pump Brass Cap Kit



AVCVAC

1/2" SAE

3/8" SAE

1/4" SAE

1/2" ACME

Vacuum pump cap kit with chains on one common ring

CPS[®] PRO-SET[®] REFRIGERANT RECOVERY MACHINES

PRO-SET[®] Oil-Less Refrigerant Recovery Machine

CYCLONE 1HP



CR700

- Fastest overall ARI certified recovery rates in its class
- Powerful 1HP oil-less reciprocating recovery compressor
- Exceptional compressor, condensing & cooling systems allow fast recovery in high temperature environments
- Automatic Low Pressure shut-off feature turns unit off when recovery is completed
- Rugged high density double walled plastic housing with easy view top mounted controls
- R-410A ready with 38 bar high pressure shut-off switch
- Ergonomic well balanced design for easy transport including shoulder strap - weighs 36 lbs/16.2kg
- Built-in suction filter located under suction port
- Worldwide patents pending

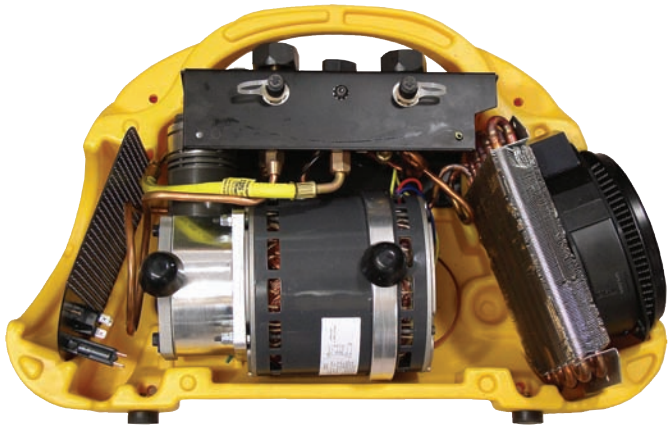

- Compact modular design with easy access 4 bolt latching system
- Complete compressor rebuilt in minutes
- Externally serviceable valves and gauges
- Integrated component moorings for quiet operation
- Fewer components equals more reliability



Oversized Piston



Larger discharge port

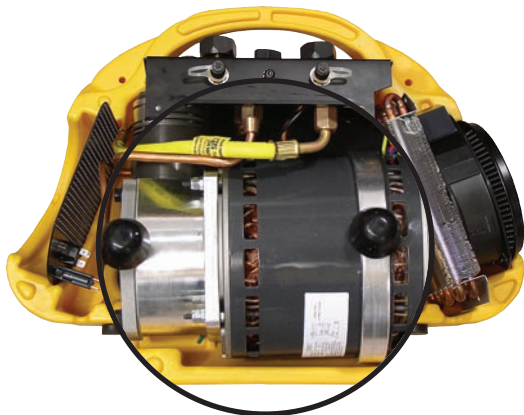

- Powerful 1HP oil-less reciprocating recovery compressor
- Oversized piston head & cylinder combined with a larger discharge port
- No suction valve eliminates failures caused by liquid slugs
- Heavy duty components with special long-lasting composite seals

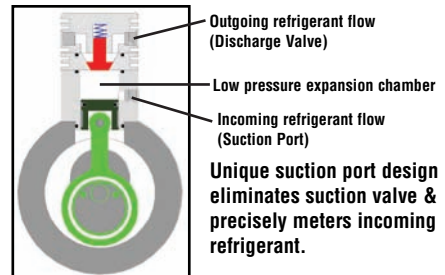

CPS[®] PRO-SET[®] REFRIGERANT RECOVERY MACHINES

PRO-SET[®] Oil-Less Refrigerant Recovery Machine

CR700 Series			
Item	Voltage	Gauges	Hoses
CR700EC	220-240V	BAR/kPa	No
CR700ECH	220-240V	BAR/kPa	Includes 180cm Premium BV Hoses (1) HP6RE (1) HP6BE
CR700JUK	110 V (UK version)	BAR/kPa	No
CR700JUKCH	110 V (UK version)	BAR/kPa	Includes 180cm Premium BV Hoses (1) HP6RE (1) HP6BE

	CR700JUK	CR700E
Direct Vapor	Up to (37 kg/hr)	
Direct Liquid	Up to (230 kg/hr)	
Push-Pull Liquid	Up to 20 lb/min (460 kg/hr)	
Compressor Type	1 HP oil-less reciprocating compressor	
Dimensions	20cm (8") wide x 37cm (14.5") long x 30.5cm (12") high	
Weight	15.3kg (34lbs.)	
Oprtg. Temp. Range	0°C (32°F) to 49°C (120°)	
Power Source	115V 50/60Hz 1 HP	220-240V 50/60 Hz 1 HP
Power Consumption	850 W	
Filtration	Cleanable 100-mesh screen integrated into Suction Port	
Shut-off valves	Both Suction and Discharge piston manifold valves	
Overload Protection	15 amp	8 amp

Rates on this table @ 50Hz

Competitive Comparison Recovery Rates

	Refrigerant	Test Conditions at 75 F Degrees			104 F Degrees	NRTL Ratings
		Liquid (kg/m)	Push / Pull (kg/m)	Vapor (kg/m)	High Temp Vapor (kg/m)	
CPS CR700	R410A	2.95	6.97	0.23		(UL) QVBC SA12068
Appion G5	R410A	1.58	4.63	0.30		(UL) QVBC SA13136
Yellow Jkt 95760	R410a	0.76	5.54	0.22		(UL) QVBC SA12038
Promax RG5410EX	R410A	2.33	6.39	0.20		(UL) QVBC SA12994
Promax RG5410A	R410A	1.85	4.91	0.16		(UL) QVBC SA12994
Inficon Vortex AC	R410A	1.66	5.15	0.08		(UL) QVBC SA12798
Stinger 2000-3300	R410A	1.37	6.63	0.10		(AR) RRRE-05040-1Q
CPS CR700	R22	3.11	7.17	0.22	0.242	(UL) QVBC SA12068
Appion G5	R22	2.82	7.54	0.28	0.19	(UL) QVBC SA13136
Yellow Jkt 95760	R22	0.90	6.12	0.15	0.15	(UL) QVBC SA12038
Promax RG5410EX	R22	1.90	6.58	0.18	0.14	(UL) QVBC SA12994
Promax RG5410A	R22	1.81	4.32	0.15	0.13	(UL) QVBC SA12994
Inficon Vortex AC	R22	1.35	2.50	0.11	0.13	(UL) QVBC SA12798
Stinger 2000-3300	R22	1.60	5.58	0.13	0.13	(AR) RRRE-05040-1Q
CPS CR700	R134	2.15	6.30	0.15		(UL) QVBC SA12068
Appion G5	R134	1.97	5.03	0.19		(UL) QVBC SA13136
Yellow Jkt 95760	R134	1.13	6.12	0.10		(UL) QVBC SA12038
Promax RG5410EX	R134	1.09	5.30	0.14		(UL) QVBC SA12994
Promax RG5410A	R134	1.57	3.63	0.11		(UL) QVBC SA12994
Inficon Vortex AC	R134	1.13	3.44	0.10		(UL) QVBC SA12798
Stinger 2000-3300	R134	1.21	4.98	0.10		(AR) RRRE-05040-1Q

Rates on this table @ 60Hz, for 50Hz reduce by 15%

Copyright © 2008 Underwriters Laboratories Inc.®

Reprinted from the Online Certifications Directory with permission from Underwriters Laboratories Inc.

Above information derived from independent test results viewable at <http://www.ul.com> and <http://www.ari.org>
 Ritchie, ATP, Inficon/VORTEX, BACHARACH/STINGER, RefTec/MicroVAC are all registered trademarks of their respective companies

CPS[®] PRO-SET[®] REFRIGERANT RECOVERY MACHINES

PRO-SET[®] Portable Units for Commercial Recovery



CR400EC

With 1/6 HP hermetic compressor, cap direct vapor: up to 17 kg/h - direct liquid: up to 23 kg/h - push-pull: up to 190 kg/h, operating range: 0- 49°C, 230VAC/50-60Hz, overload protection: 4 amp thermal circuit breaker, power consumption: 350W, weight 12.6 kg, CE/TÜV-GS

CR400ECH = CR400C + (2) 180cm BV hose

Portable units for commercial recovery, suitable for all refrigerants, including R-410A



CR500EC

With 1/3 oil-less compressor, manual reuglating valve, capacity direct vapor: up to 24 kg/h - direct liquid: up to 50 kg/h - push-pull: up to 255 kg/h, operating range: 0-49°C, overload protection: 5 amp thermal circuit breaker, power consumption: 500W, 230VAC/50-60Hz, weight: only 8.8 kg!, CE/TÜV-GS

CR500ECH = CR500EC + (2) 180cm BV hose

Portable units for commercial recovery, suitable for all refrigerants, including R-410A



CR600EC

With 1/2 oil-less compressor, cap. direct vapor: > 27 kg/h - direct liquid: > 68 kg/h - push-pull: >272 kg/h, operating range: 0-49°C, overload protection: 6 amp thermal circuit breaker, power consumption: 750W, 230VAC / 50-60Hz, weight: 13.1 kg, CE/TÜV-GS,

CR600ECH = CR600EC + (2) 180cm BV hose

Portable units for commercial recovery, suitable for all refrigerants, including R-410A

	CR400EC	CR500EC	CR600EC
Application	Appliances, Small, A/C Units, Automobiles	Residential A/C, Refrigeration, Commercial	Residential A/C, Refrigeration, Commercial
Compressor	1/6 HP Hermetic	1/3 HP Oil-less	1/2 HP Oil-less
Voltage	230 VAC 50-60Hz	230 VAC 50-60Hz	230 VAC 50-60Hz
Weight	12.6 kg/28lbs	8.8kg/20lbs	12.1kg/29lbs
Approvals	CE/TÜV-GS	CE/TÜV-GS	CE/TÜV-GS

Flow ratings at 50Hz



CPS[®] PRO-SET[®] REFRIGERANT RECOVERY MACHINES

Refrigerant Recycling Module



FEATURES:

- Easy access one bolt cover with 42 cubic inch solid core drier.
- High efficiency coalescent oil separator to remove oil and other contaminants from refrigerant.
- Ball Valves on the hoses for easy hook up and safe disconnection.
- Built in manifold with self clearing valve. Prepares the unit for the next refrigerant.
- Manifold utilizes CPS exclusive Triple Seal piston valves.
- Suction and discharge gauges for monitoring operation.
- 1/4" SAE Male flare oil drain port to remove recovered oil and contaminants.
- Light weight (15lbs) and ergonomically designed handle for portability.
- Heavy duty powder coated aluminum chassis surrounded by a tough high-density polyethylene case.
- 1/4" SAE Male flare fittings.

*Operates with all brands of recovery machines

CRXRM

CR Series Replacement Parts / Recovery Tanks

Replacement Parts	
ARXF	Filter Replacement for CRXRM
CRXCR1	Compressor Rebuild Kit for CR600 (all)
CRXCR2	Compressor Rebuild Kit for CR500 (115V)
CRXCR3	Compressor Rebuild Kit for CR500 (230V)
CRXCR4	Motor Brush Kit for CR500 (115V)
CRXCR5	Motor Brush Kit for CR500 (230V)
CRXCR6	Piston Seal for CR500
CRXCR7	Piston Seal for CR600
CRXCR8	Compressor Rebuild Kit for CR700 (all)
CRXTOS2	CR Overfill Sensor Cord Kit 115V
CRXTOS3	CR Overfill Sensor Cord Kit 230V
CRXF2	(6) Suction Filters for CR300, 400, 500, 600
CRXF3	(6) Suction Filters for CR700

Refrigerant Recovery Tank

ITEM	DESCRIPTION	Water Capacity	Approvals	Service Pressure
T40L	40 Liter tank with 1/4" SAE M	70.0lb / 31.7kg	"E" Mark	32 BAR

T40L
1/4" SAE Male Ports



cps[®]

PRO-SET[®]

VORTECH SERIES

VORTECH VALVE SYSTEM[™]
PATENT PENDING

- Advanced VVS diaphragm valve system
- Certified 15 micron vacuum rating
- Red & blue protective gauge boots
- New 45° fittings for easy hose storage (2 valve series only)
- Anodized aircraft aluminum block body
- Precision flutter-free metal cased gauges
- Heavy duty plastic valve handles
- Oversized refrigerant sight glass

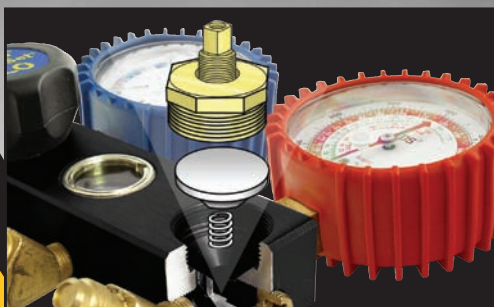

- Advanced diaphragm valve design
- Superior refrigerant metering capabilities
- Certified 5 year trouble-free valve life
- Maximum unrestricted refrigerant flow
- Light touch valve operation



1 VALVE SERIES

2 VALVE SERIES

4 VALVE SERIES

5 VALVE SERIES



MV1GH

R-12 R-22 R-502



MV2V

R-134a R-22 R-404A



MV4J

R-134a R-407C R-404A R-22



MV5ND

R-12 R-22 R-502

Gauge Description		R-12, R22, R502	R134a, R404A, R407C	R410A, R22, R407C	R22, R134a, R404A, R407C	R22, R134A, R404A, R407C	R410A, R22, R407C	R12, R22, R502	R134a, R404A, R407C, R507	R12, R22, R502	R134a, R404A, R407C, R507	R22, R134a, R404A, R407C	R134a
		68mm	68mm	68mm	80mm	80mm	80mm	80mm	80mm	80mm	80mm	80mm	80mm
		BAR/PSI	BAR/PSI	BAR/PSI	BAR/PSI	BAR/PSI	BAR/PSI	BAR/PSI	BAR/PSI	BAR	BAR	BAR	BAR
		Class 1.6	Class 1.6	Class 1.6	Class 1.6	Class 1.6	Class 1.6	Class 1.6	Class 1.6	Class 1	Class 1	Class 1	Class 1
		°C	°C	°C	°C	°C	°C	°C	°C	°C	°C	°C	°C
Refrigerant Scales	Low Side	RGGH	RGFH	RG0H	RGJH	RGJH	RG02H	RGNH	RGKH	RG0H	RGWH	RGUH	RGLH
	High Side	RGGL	RGFL	RG0L	RGJL	RGJL	RG02L	RGNL	RGKL	RG0L	RGWL	RGUL	RGLL
Diameter	Low Side	MV1GL	MV1FL	MV10L	MV1JL	MV1J3L	MV102L	MV1NL	MV1KL	MV10L	MV1WL	MV1UL	MV1LL
	High Side	MV1GH	MV1FH	MV10H	MV1JH	MV1J3H	MV102H	MV1NH	MV1KH	MV10H	MV1WH	MV1UH	MV1LH
Pressure Scales	Manifold & Gauges Only	MV2G	MV2F	MV20	MV2J	MV2J3	MV202	MV2N	MV2K	MV20	MV2W	MV2U	MV2L
	w/ 90cm Hoses	MV2GS3	MV2FS3	MV20S3	MV2J3S3	MV2J3S3	MV202S3	MV2NS3	MV2KS3	MV20S3	MV2WS3	MV2US3	MV2LS3
	w/ Carry Case	MV2GS3C	MV2FS3C	MV20S3C	MV2J3S3C	MV2J3S3C	MV202S3C	MV2NS3C	MV2KS3C	MV20S3C	MV2WS3C	MV2US3C	MV2LS3C
	w/ 150cm Hoses	MMV2GS5	MV2FS5	MV20S5	MV2J3S5	MV2J3S5	MV202S5	MV2NS5	MV2KS5	MV20S5	MV2WS5	MV2US5	MV2LS5
w/ Carry Case	MMV2GS5C	MV2FS5C	MV20S5C	MV2J3S5C	MV2J3S5C	MV202S5C	MV2NS5C	MV2KS5C	MV2KS5C	MV20S5C	MV2WS5C	MV2US5C	MV2LS5C
4 Valve Manifold	Manifold & Gauges Only	MV4G	MV4F	MV40	MV4J	MV4J3	MV402	MV4N	MV4K	MV4Q	MV4W	MV4U	MV4L
	w/ 150cm Hoses	MV4GS5	MV4FS5	MV40S5	MV4J3S5	MV4J3S5	MV402S5	MV4NS5	MV4KS5	MV4QS5	MV4WS5	MV4US5	MV4LS5
	w/ Carry Case	MV4GS5C	MV4FS5C	MV40S5C	MV4J3S5C	MV4J3S5C	MV402S5C	MV4NS5C	MV4KS5C	MV4QS5C	MV4WS5C	MV4US5C	MV4LS5C
	w/ 150cm BV Hoses	MV4GS5E	MV4FS5E	MV40S5E	MV4J3S5E	MV4J3S5E	MV402S5E	MV4NS5E	MV4KS5E	MV4QS5E	MV4WS5E	MV4US5E	MV4LS5E
w/ Carry Case	MV4GS5EC	MV4FS5EC	MV40S5EC	MV4J3S5EC	MV4J3S5EC	MV402S5EC	MV4NS5EC	MV4KS5EC	MV4QS5EC	MV4WS5EC	MV4US5EC	MV4LS5EC	
5 Valve Manifold	Manifold, Gauges & Analog Vac. Gauge	N/A	N/A	N/A	MV5J	MV5J3	N/A	MV5N	MV5K	MV5Q	MV5W	MV5U	MV5L
	Manifold, Gauges & Digital Vac. Gauge	N/A	N/A	N/A	MV5JD	MV5J3D	N/A	MV5ND	MV5KD	MV5QD	MV5WD	MV5UD	MV5LD
	w/ 150cm BV Hoses, Analog Vac. Gauge & Case	N/A	N/A	N/A	MV5J5PEC	MV5J35PEC	N/A	MV5N5PEC	MV5K5PEC	MV5Q5PEC	MV5W5PEC	MV5U5PEC	MV5L5PEC
	w/ 150cm BV Hoses, Digital Vac. Gauge & Case	N/A	N/A	N/A	MV5J5PECD	MV5J36PECD	N/A	MV5N5PECD	MV5K6PECD	MV5Q6PECD	MV5W6PECD	MV5U6PECD	MV5L5PECD



PRO-SET®

VORTECH SERIES

VORTECH™ Anodized Pink Body For R-410A

All Gauges have Protective Rubber Boots Except for Oil Filled Type

- Advanced VVS diaphragm valve system
- Red & blue protective gauge boots
- New 45° fittings for easy hose storage (2 valve series only)
- Anodized aircraft aluminum block body
- Precision flutter-free metal cased gauges
- Heavy duty metal valve handles
- Oversized refrigerant sight glass
- Advanced one-piece diaphragm valve design
- Superior refrigerant metering capabilities
- Vacuum rated to 15 microns or better
- Certified 5 year trouble-free valve life
- Maximum unrestricted refrigerant flow
- Light touch valve operation



**MV1202
R-410A**



**MV11E
R-410A**



**MV110
R-410A**

Gauge Description	Refrigerant Scales	R410A, R22, R407C	R410A	R410A, R22, R407C	R410A	R410A, R22, R407C
	Diameter	68mm	80mm	80mm	80mm	80mm
	Pressure Scales	BAR/PSI	BAR/PSI	BAR/PSI	BAR	BAR/PSI
	Accuracy	Class 1.6	Class 1.6	Class 1.6	Class 1	Class 1
	Temperature Scales	°C	°C	°C	°C	°C

Rplmt. Gauges	Low Side	RG0H	RGAH	RG02H	RGEH	RG04H
	High Side	RG0L	RGAL	RG02L	RGEL	RG04L

MV11 2 Valve Manifold	Manifold & Gauges Only	MV110	MV11A	MV1102	MV11E	MV1104
	w/ 150cm Hoses	MV110J5	MV11AJ5	MV1102J5	MV11EJ5	MV1104J5
	w/ Carry Case	MV110J5C	MV11AJ5C	MV1102J5C	MV11EJ5C	MV1104J5C
	w/ 150cm BV Hoses	MV110J5E	MV11AJ5E	MV1102J5E	MV11EJ5E	MV1104J5E
	w/ Carry Case	MV110J5EC	MV11AJ5EC	MV1102J5EC	MV11EJ5EC	MV1104J5EC

MV12 4 Valve Manifold	Manifold & Gauges	MV120	MV12A	MV1202	MV12E	MV1204
	w/ 150cm Hoses	MV120J5	MV12AJ5	MV1202J5	MV12EJ5	MV1204J5
	w/ Carry Case	MV120J5C	MV12AJ5C	MV1202J5C	MV12EJ5C	MV1204J5C
	w/ 150cm BV Hoses	MV120J5E	MV12AJ5E	MV1202J5E	MV12EJ5E	MV1204J5E
	w/ Carry Case	MV120J5EC	MV12AJ5EC	MV1202J5EC	MV12EJ5EC	MV1204J5EC

* All Manifolds 1/2"-20



SERVICE MANIFOLD & GAUGES

BLACKMAX™ 2-Valve Piston Valve Manifolds With 1/4" SAE Fittings



R-134a | R-22 | R-404A

- No flutter gauges with rugged Metal housings
- Aluminum block
- Additional Schraeder® valve "T" port
- Large easy-to-grip knobs



R-134a | R-22 | R-404A

- Exclusive TripleSeal™ valve system
- Valve stems retract fully for maximum flow
- Back seating o-ring seals valve nut when fully open

TRIPLE SEAL™ VALVES

NEW TRIPLE-SEAL™ PISTON VALVE SYSTEM

- Three Super Neoprene o-ring design
- Back-seating o-ring seals valve nut when fully open
- Floating nylon sealing disk
- Valve stems retract fully to provide maximum flow
- Mirror-like port finish for smooth valve movement

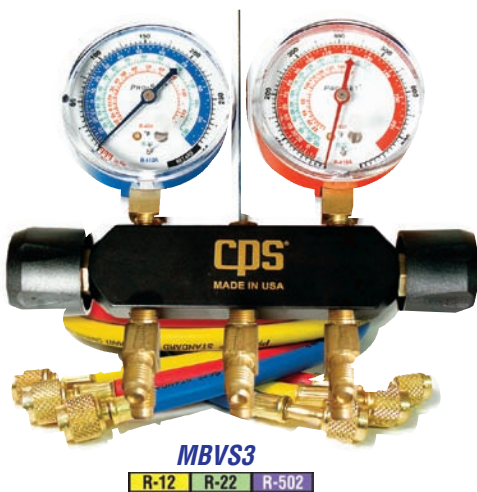

R-12 | R-22 | R-502

Gauge Description	Refrigerant Scales	R12, R22, R502	R134A, R404A, R407C	R410A, R22, R407C	R22, R134A, R404A
	Diameter	68mm	68mm	68mm	68mm
	Pressure Scales	BAR/PSI	BAR/PSI	BAR/PSI	BAR/PSI
	Accuracy	Class 1.6	Class 1.6	Class 1.6	Class 1.6
	Temperature Scales	°C	°C	°C	°C

Rplmt. Gauges	Low Side	RGGH	RGFH	RGOH	RGVH
	High Side	RGGL	RGFL	RGOL	RGVL

MB	Manifold & Gauges Only	MBG	MBF	MBO	MBV
	w/ 90cm Hoses	MBGS3	MBFS3	MBOS3	MBVS3
	w/ 150cm Hoses	MBGS5	MBFS5	MBOS5	MBVS5

MC R410A 1/2" - 20	Manifold & Gauges	N/A	N/A	MCO	N/A
	w/ 90cm Hoses	N/A	N/A	MCOJ3	N/A
	w/ 150cm Hoses	N/A	N/A	MCOJ5	N/A



SERVICE MANIFOLD & GAUGES

Hydro-Carbon Manifold Sets

2 Valve Manifold	Vortech Series Manifolds	
	Manifold & Gauges	MV2HC
	w/ 150cm Hoses*	MV2HCP5E
*Only available with premium hoses		
4 Valve Manifold	BlackMax Series Manifolds	
	Manifold & Gauges	MBHC
	w/ 150cm BV Hoses*	MBHCP5E
*Only available with premium hoses		
5 Valve Manifold	Manifold & Gauges	MV4HC
	w/ 150cm BV Hoses*	MV4HC5PE
	w/ Carry Case*	MV4HC5PEC
*Only available with premium hoses, also includes 3/8 Vacuum Hose		
5 Valve Manifold	Mnfl, Gauges & Analog Vac.Gauge	MV5HC
	w/ 150cm BV Hoses, Analog Vac.Gauge & Case*	MV5HC5PE
	w/ 150cm BV Hoses, Digital Vac.Gauge & Case*	MV5HCD5PEC
*Only available with premium hoses, also includes 3/8 Vacuum Hose		



MV2HC

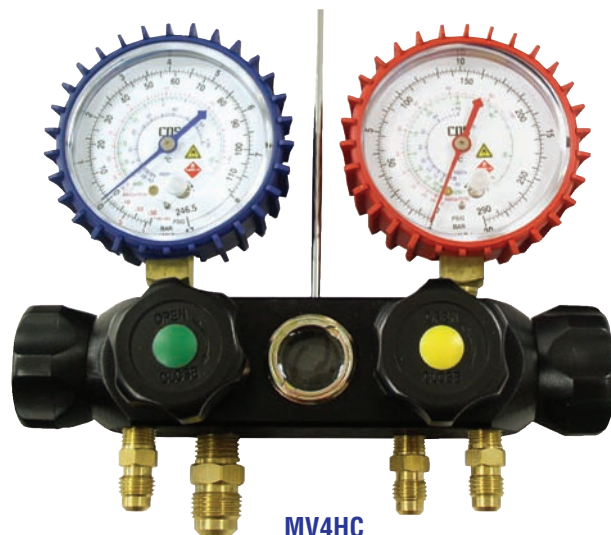

MV4HC



MV5HC



SERVICE MANIFOLD & GAUGES

2-Valve Brass Manifolds With 1/4" SAE Fittings

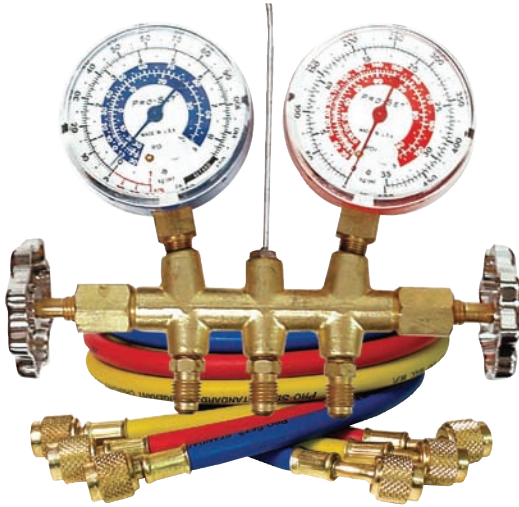

Gauge Description	Refrigerant Scales	R12, R22, R502	R134A, R404A, R407C	R410A, R22, R407C	R22, R134A, R404A
	Diameter	68mm	68mm	68mm	68mm
	Pressure Scales	BAR/PSI	BAR/PSI	BAR/PSI	BAR/PSI
	Accuracy	Class 1.6	Class 1.6	Class 1.6	Class 1.6
	Temperature Scales	°C	°C	°C	°C

Rplmt. Gauges	Low Side	RGGH	RGFH	RG0H	RGVH
	High Side	RGGL	RGFL	RGOL	RGVL

M6 2 Valve	Manifold & Gauges Only	M6G	M6F	M6O	M6V
	w/ 90cm Hoses	M6GS3	M6FS3	M6OS3	M6VS3
	w/ 150cm Hoses	M6GS5	M6FS5	M6OS5	M6VS5

Brass Manifolds

- Quality forged brass body
- Sliding double o-ring piston valve system
- Full sized porting for maximum flow
- No flutter gauges with rugged Metal housings
- Large easy-to-grip knobs

Manifold Accessories

M2XHA	2-way hose anchor bracket for Vortech & diaphragm
M2XRK	Diaphragm valve repair kit: services 2 valves
M4XHA	4-way hose anchor bracket for Vortech & diaphragm
M4XRK	Diaphragm valve repair kit: services 4 valves
M5XRK	Diaphragm valve repair kit: services 5 valves
MV2XRK	Vortech valve repair kit: services 2 valves
MV4XRK	Vortech valve repair kit: services 4 valves
MV5XRK	Vortech valve repair kit: services 5 valves
MVXK	Replacement valve handle w/ plugs for Vortech manifolds
MXBK	Replacement valve handle for brass manifold
MXC	Plastic carrying case for manifolds
MXK	Replacement valve handle w/ labels for diaphragm manifolds
MXMH	Hanging hook for all manifolds
MXPK	Replacement valve handle w/ labels for BLACKMAX manifolds
MPV	Complete BLACKMAX piston valve assembly
MPVO	BLACKMAX piston valve seals repair kit: services 2 valves

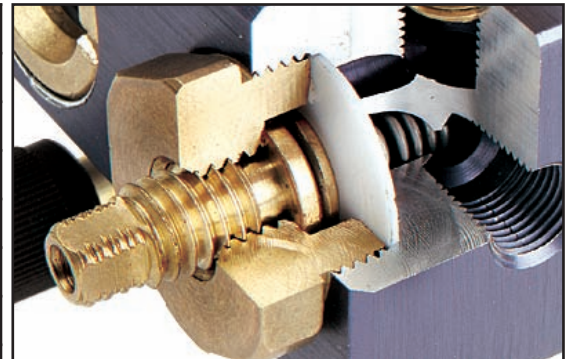

cps®

PRESSURE GAUGES

NEW!

PRO-SET® 2 1/2" 68mm Pressure Gauges

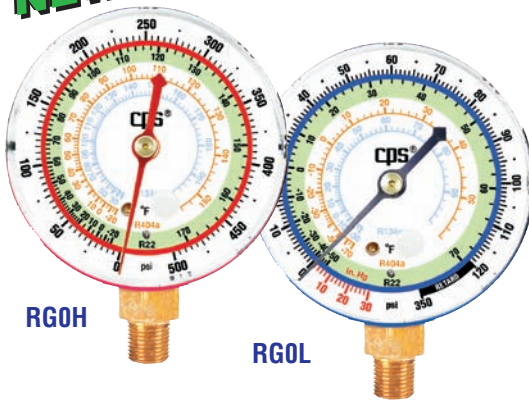

- No-flutter gauge design
- Easy to read color coded dials
- Durable metal casing
- Front calibration access port
- High impact pop-in lexan lens
- 1/8" NPT brass connection

R-410a R-22 R-407C

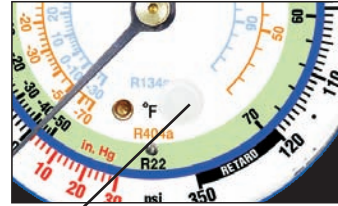

Calibration access port

PRO-SET® 3 1/8" /80mm Pressure Gauges

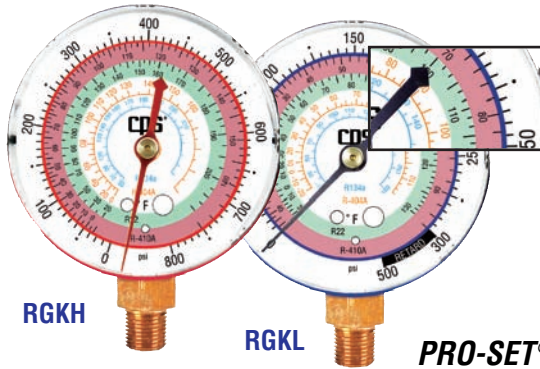

- Extra large easy to read scales
- No-flutter gauge design
- Durable metal casing
- Front calibration access port
- High impact pop-in lexan lens
- 1/8" NPT brass connection

R-134a R-407C R-404A R-507A

PRO-SET® 3 1/8" /80mm Oil-Filled Pressure Gauges



Fill Port

- Extra large scales
- No-flutter gauge design
- Rear calibration access port
- 1/8" NPT brass connection

R-22 R-134a R-404A R-407C

Protective Rubber Gauge Boots

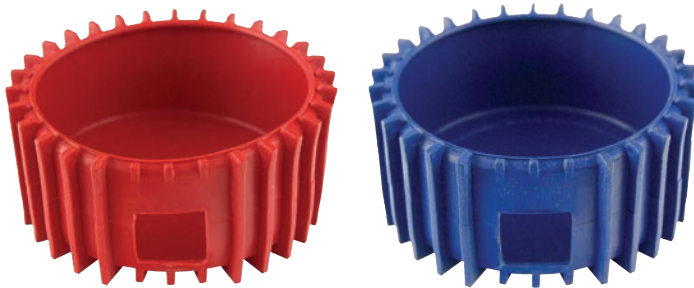

Gauge Boots	Red	Blue
68mm Rubber Boots	RGX68RB	RGX68BB
80mm Rubber Boots	RGX80RB	RGX80BB

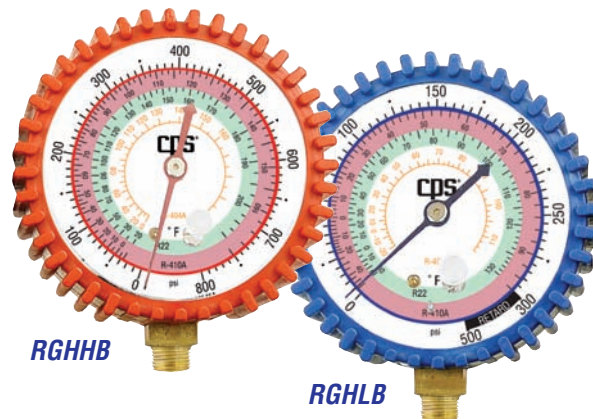

RGHHB

RGHLB

FITS MOST MANUFACTURERS MODELS

68mm Replacement Gauges

Gauge Description		R-12, R22, R502	R134a, R404A, R407C	R22, R134a, R404A	R410A, R22, R407C	R600a, R290, R600a/R290 blend
Refrigerant Scales		68mm	68mm	68mm	68mm	68mm
Diameter		BAR/PSI	BAR/PSI	BAR/PSI	BAR/PSI	BAR/PSI
Pressure Scales		Class 1.6	Class 1.6	Class 1.6	Class 1.6	Class 1.6
Accuracy		°C	°C	°C	°C	°C
Temperature Scales						

Rpmt. Gauges

Low Side	RGGH	RGFH	RGVH	RGOH	RGCH
High Side	RGGL	RGFL	RGVL	RGOL	RGCL

Rpmt. Gauges

Low Side w/ Rubber Boot	RGGHB	RGFHB	RGVHB	RGOHB	RGCHB
High Side w/ Rubber Boot	RGGLB	RGFLB	RGVLB	RGOLB	RGCLB

Replacement Gauges

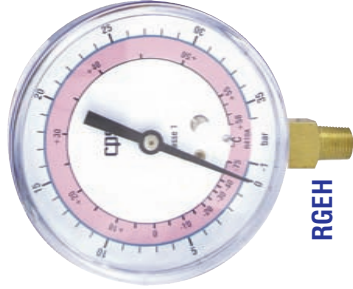

RGEH

RGHCLB

RGWL

80mm Replacement Gauges

Gauge Description		R22, R134a, R404A, R407C	R22, R134a, R404A, R407C	80mm Oil Filled	R410A, R22, R407C	R12, R22, R502	R134a, R404A, R407C, R507	R22, R134a, R404A, R407C	R134a	R410A	R410A, R22, R407C
Refrigerant Scales		80mm	80mm	80mm	80mm	80mm	80mm	80mm	80mm	80mm	80mm
Diameter		BAR/PSI	BAR/PSI	BAR/PSI	BAR/PSI	BAR/PSI	BAR	BAR	BAR	BAR/PSI	BAR/PSI
Pressure Scales		Class 1.6	Class 1.6	Class 1.6	Class 1.6	Class 1	Class 1	Class 1	Class 1	Class 1.6	Class 1
Accuracy		°C	°C	°C	°C	°C	°C	°C	°C	°C	°C
Temperature Scales											

Rpmt. Gauges

Low Side	RGJH	RGJ8H	RG02H	RGKH	RGQH	RGUH	RGWH	RGUH	RGLH	RGAH	RG04H
High Side	RGJL	RGJ8L	RG02L	RGKL	RGOL	RGUL	RGWL	RGUL	RGLL	RGAL	RG04L

Rpmt. Gauges

Low Side w/ Rubber Boot	RGJHB	RGJ8HB	RG02HB	RGKHB	RGQHB	RGUHB	RGWHB	RGUHB	RGLHB	RGAHB	RG04HB
High Side w/ Rubber Boot	RGJLB	RGJ8LB	RG02LB	RGKLB	RGOLB	RGULB	RGWLB	RGULB	RGLLB	RGALB	RG04LB



Gas Test Gauge / Fuel Oil Test Kit

Gas Pressure Test Assemblies

The **GT1** and **GT2** are designed to test the integrity of new installations for pressure leaks. Available with either a 3/4" or 1" FPT brass bell. Simply connect the test assembly, pressurize the system using the supplied access port and monitor the easy-to-read 3 1/2" / 80mm gauge for potential pressure drops that would indicate a leak.



- GT1**
GAS TEST GAUGE
- Large 3 1/8" gauge - easy to read
 - 0-30 PSIG (0-2 BAR) pressure scale
 - 1 PSIG increments
 - 3/4" FPT hex style brass bell
 - Access valve



- GT2**
GAS TEST GAUGE
- Large 3 1/8" gauge - easy to read
 - 0-100 PSIG (0-7 BAR) pressure scale
 - 2 PSIG increments
 - 3/4" FPT hex style brass bell
 - Access valve

Fuel Oil Test Kit

The **GT3** is a comprehensive test kit which includes the components necessary to test oil fuel pump performance while diagnosing related burner efficiency issues such as cleaner light-offs and coasting stops.



GT3



Carrying case included with kit

FUEL OIL TEST KIT

Includes:

- 2 1/2" gauge, scale 30", 0-150 lbs.
- 2 1/2" gauge, scale 30", 0-300 lbs
- 12" hose 1/4" Fem swivel x 1/4" Fem 45° swivel
- 1/8 NPT x 1/4 Male SAE adapter
- 1/8 NPT x 1/4 Male SAE 90° adapter
- 1/4 NPT x 1/4 Male SAE adapter
- 1/4 NPT x 1/4 Male SAE 90° adapter
- Carrying Case



STANDARD CHARGING HOSES

STANDARD

- All-weather flexibility and strength
- Extra deep knurling on nuts for easy grip
- 750 psi working pressure; 3000 psi burst
- 1/4" SAE fittings with 45° bend on one end
- Available with MicroSeal™ or ball valve fittings
- Leak-proof eight-sided crimp
- Blow-off grooves channel refrigerant to prevent spray back

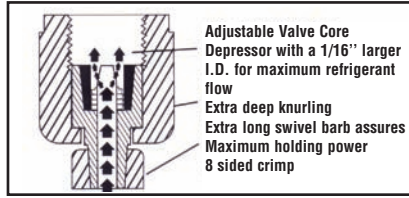

PREMIUM

- R-410A Compatible
- 800 psi working pressure; 4000 psi burst
- Environment friendly Nylon Permeation Barrier meets SAE J2196
- Compatible with CFC, HCFC and HFC refrigerants & blends
- Available with MicroSeal™ or ball valve fittings

Adjustable valve core depressor opens all out of tolerance Schraeder® valves.

1/4" Standard Hoses

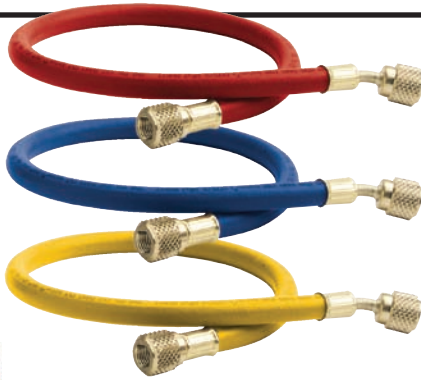

LENGTH	YELLOW	BLUE	RED	3-PACK
3' - 90cm	HS3Y	HS3B	HS3R	HS3
4' - 120cm	HS4Y	HS4B	HS4R	HS4
5' - 150cm	HS5Y	HS5B	HS5R	HS5
6' - 180cm	HS6Y	HS6B	HS6R	HS6
8' - 240cm	HS8Y	HS8B	HS8R	HS8
10' - 300cm	HS10Y	HS10B	HS10R	HS10

HXG - Replacements 1/4" Gaskets (10) HXD - Replacements Depressors (10)

1/4" Standard Hoses With 45° Ball Valve On End

LENGTH	YELLOW	BLUE	RED	3-PACK
3' - 90cm	HS3YE	HS3BE	HS3RE	HS3E
5' - 150cm	HS5YE	HS5BE	HS5RE	HS5E
6' - 180cm	HS6YE	HS6BE	HS6RE	HS6E
8' - 240cm	HS8YE	HS8BE	HS8RE	HS8E

HXG - Replacements 1/4" Gaskets (10) HXD - Replacements Depressors (10)



1/4" Standard Hoses With MICROSEAL™ Anti-Blowback Valve On One End



Super compact design (.75" x 1", 19mm x 25mm) enables access to service ports in tight quarters

LENGTH	YELLOW	BLUE	RED	3-PACK
3' - 90cm	HS3YA	HS3BA	HS3RA	HS3A
5' - 150cm	HS5YA	HS5BA	HS5RA	HS5A
6' - 180cm	HS6YA	HS6BA	HS6RA	HS6A
8' - 240cm	HS8YA	HS8BA	HS8RA	HS8A

HXG - Replacements 1/4" Gaskets (10) HXD - Replacements Depressors (10)

1/4" Standard In-Line Ball Valve Hoses

LENGTH	YELLOW	BLUE	RED	3-PACK
3' - 90cm	HS3YL	HS3BL	HS3RL	HS3L
5' - 150cm	HS5YL	HS5BL	HS5RL	HS5L
6' - 180cm	HS6YL	HS6BL	HS6RL	HS6L
8' - 240cm	HS8YL	HS8BL	HS8RL	HS8L

HXG - Replacements 1/4" Gaskets (10) HXD - Replacements Depressors (10)





PREMIUM CHARGING HOSES

1/4" Premium Hoses For All Refrigerants

LENGTH	YELLOW	BLUE	RED	3-PACK
3' - 90cm	HP3Y	HP3B	HP3R	HP3
5' - 150cm	HP5Y	HP5B	HP5R	HP5
6' - 180cm	HP6Y	HP6B	HP6R	HP6

HXG - Replacement 1/4" Gaskets (10) HXD - Replacement Depressors (10)

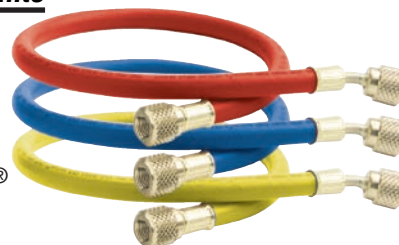

1/4" Premium Hoses With 45° Ball Valve On End



LENGTH	YELLOW	BLUE	RED	3-PACK
3' - 90cm	HP3YE	HP3BE	HP3RE	HP3E
5' - 150cm	HP5YE	HP5BE	HP5RE	HP5E
6' - 180cm	HP6YE	HP6BE	HP6RE	HP6E

HXG - Replacement 1/4" Gaskets (10) HXD - Replacement Depressors (10)

1/4" Premium Hoses With MICROSEAL™ Anti-Blowback Valve On One End

LENGTH	YELLOW	BLUE	RED	3-PACK
3' - 90cm	HP3YA	HP3BA	HP3RA	HP3A
5' - 150cm	HP5YA	HP5BA	HP5RA	HP5A
6' - 180cm	HP6YA	HP6BA	HP6RA	HP6A

HXGA - Replacements Gaskets (6)



Super compact design (.75" x 1", 19mm x 25mm) enables access to service ports in tight quarters



1/4" Premium In-Line Ball Valve Hoses

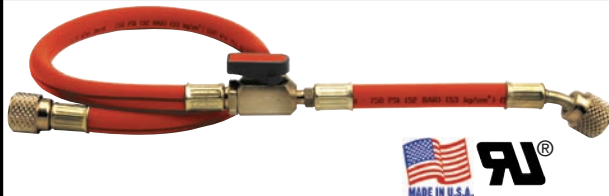

LENGTH	YELLOW	BLUE	RED	3-PACK
3' - 90cm	HP3YL	HP3BL	HP3RL	HP3L
5' - 150cm	HP5YL	HP5BL	HP5RL	HP5L
6' - 180cm	HP6YL	HP6BL	HP6RL	HP6L

HXG - Replacement 1/4" Gaskets (10) HXD - Replacement Depressors (10)

R-410A Premium Hose w/ Special 1/2"-20 UNF Fittings

LENGTH	YELLOW	BLUE	RED	3-PACK
3' - 90cm	HJ3Y	HJ3B	HJ3R	HJ3
5' - 150cm	HJ5Y	HJ5B	HJ5R	HJ5

WITH 45° BALL VALVE FITTING IN ONE END				
3' - 90cm	HJ3YE	HJ3BE	HJ3RE	HJ3E
5' - 150cm	HJ5YE	HJ5BE	HJ5RE	HJ5E

HXG2 - Gaskets (10) (1/2" ACME) & (1/2" - 20 UNF)
 HXTG2 - Teflon Gaskets (10) (1/2" ACME) & (1/2" - 20 UNF)
 HXD - Replacement Depressors (10)

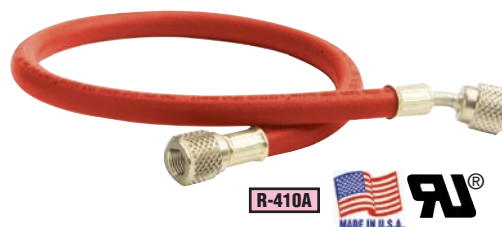

6" - 12" Ball Valve Hose Extensions



LENGTH	FITTINGS	YELLOW	BLUE	RED	3 - PACK
6"	1/4 SAE	HTYE	HTBE	HTRE	HTE
12"	1/4 SAE	HT1YE	HT1BE	HT1RE	HT1E
6"	1/2-20 UNF	HT410YEJ	HT410BEJ	HT410REJ	HT410EJ





PRO-SET®

SPECIALTY HOSES, REPLACEMENT GASKETS & DEPRESSORS

Premium Pressure Control Hoses



- Replaces Standard Copper Capillary Tubing
- 1/4" SAE Hex Style Fittings
- Do not exceed 203°F (95°C) for long term use

LENGTH	90° x 90°	Straight x 90°
2' - 60cm	HHC2	HHC2S
3' - 90cm	HHC3	HHC3S
4' - 120cm	HHC4	HHC4S

Premium 3/8" Vacuum/Charging Hoses



- 5/16" I.D. heavy-duty hose
- Permeation resistant barrier
- 460 psi working pressure; 2300 psi burst



HOSE P/N	LENGTH
WITHOUT BALL VALVE	
HV3	3' - 90cm
HV5	5' - 150cm
HV6	6' - 180cm
HV8	8' - 240cm

HOSE P/N	LENGTH
WITH IN-LINE BALL VALVE	
HV5E	5' - 150cm

HX38G - Replacement 3/8" Gaskets (10)



see page 51 Automotive Section

QCH14 high side
QCL14 low side

Replacement Hose Gaskets, Depressors & O-Rings

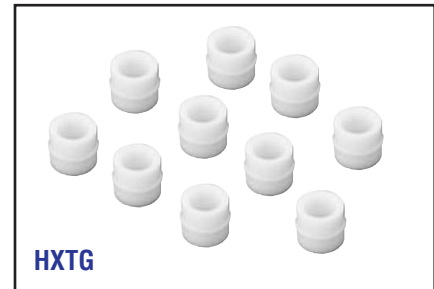

ITEM	PARTS DESCRIPTION
HXGD2	1/2"-20 UNF & 1/2" ACME Hose Gaskets
HX3G	3/16" Hose Gasket (10)
HX14R	14mm Hose Rings (10)
HX38G	3/8" Hose Gaskets (10)
HXG2	1/2" UNF & 1/2" ACME Hose Gaskets (10), core depressors (10)
HXD	1/4" SAE Hose Core Depressors (10)

ITEM	PARTS DESCRIPTION
HXGA	Microseal™ Antiblowback gaskets (10)
HXGA410	1/2"-20 UNF Microseal™ Antiblowback gaskets (10)
HXTG	1/4" SAE Teflon hose gasket (10)
HXTG2	1/2"-20 UNF & 1/2" ACME Teflon hose gasket (10)



BALL VALVES & ANTI-BLOWBACK VALVES

PRO-SET® Ball Valves

PRO-SET®

- Add to existing hose to eliminate refrigerant loss and comply with EPA regulations
- Easy 1/4 turn open/close with rugged plastic composite color-coded handles
- Oversized chrome ball for smooth operation and non-restrictive flow
- Individual valves include all three color-coded handle inserts

MALE x MALE FULL FLOW BALL VALVE



BVM
1/4" SAE Male, x 1/4" SAE Male



90° SWIVEL ELBOW x MALE FLOW FLOW BALL VALVE



BV90
1/4" SAE Female, x 1/4" SAE Male



45° SWIVEL ELBOW x MALE FULL FLOW BALL VALVE



BV45
1/4" SAE Female, x 1/4" SAE Male



SWIVEL NUT STRAIGHT x MALE FULL FLOW BALL VALVE



BV
1/4" SAE Female, x 1/4" SAE Male



Item	Qty / Pk	Female	Female	Other
BV	1	1/4" SAE	1/4" SAE	Straight
BV3	3	1/4" SAE	1/4" SAE	Straight
BV38	1	3/8" SAE	3/8" SAE	Straight
BV410	1	1/2" - 20 UNF	1/2" - 20 UNF	Straight
BV41018	1		1/2" 20 UNF x 1/8" MNPT	Straight
BV4103	3	1/2" - 20 UNF	1/2" - 20 UNF	Straight
BV41090A	1	1/2" - 20 UNF 90°	1/4" SAE	90° FM
BV410A	1	1/2" - 20 UNF	1/4" SAE	Straight
BV45	1	1/4" SAE 45°	1/4" SAE	45° FM
BV453	3	1/4" SAE 45°	1/4" SAE	45° FM
BV90	1	1/4" SAE 90°	1/4" SAE	90° FM
BV903	3	1/4" SAE 90°	1/4" SAE	90° FM
BVAD38	1	3/8" SAE	1/4" SAE	Straight
BVBH	1		1/4" SAE x 1/16" MNPT	Bulkhead
BVM	1		1/4" SAE x 1/4" SAE	Straight
BVM3	3		1/4" SAE x 1/4" SAE	Straight
BVXH	3	Replacement Ball Valve Handle w/1 ea (Yellow, Blue, Red) inserts		

Brass Gauge Adapter

MICROSEAL™ Anti-Blowback Valves



ABG18

1/4" SAE FM Anti-blowback x 1/8" NPT Female



AB90



AB

- Advanced automatic sealing valve eliminates refrigerant loss and blowback
- New micro valve technology enables use on systems with limited access to service ports
- Add to existing hose to eliminate refrigerant loss and comply with EPA regulations
- Deep easy grip knurling and non-restrictive porting for maximum refrigerant flow
- Up to 25% smaller O.D. than similar competitive models

Item	Qty / Pk	Female	Male	Other
AB	1	1/4" SAE	1/4" SAE	Straight
AB12	1	1/2" ACME	1/2" ACME	Straight
AB3	3	1/4" SAE	1/4" SAE	Straight
AB410	1	1/2" - 20 UNF	1/2" - 20 UNF	Straight
AB4103	3	1/2" - 20 UNF	1/2" - 20 UNF	Straight
AB41090A	1	1/2" - 20 UNF	1/4" SAE	90° FM
AB410A	1	1/2" - 20 UNF	1/4" SAE	Straight
AB90	1	1/4" SAE 90°	1/4" SAE	90° FM
AB903	3	1/4" SAE 90°	1/4" SAE	90° FM
ABG18	1	1/4" SAE x 1/8" FNPT		1/8" FNPT is not an AB

*HXGA - Replacement O Rings (6)



BRASS ADAPTERS

HVAC/R ADAPTERS



AD12



AD41/AD61/AD81



AD47



AVC4



AD44



AD68



AD78/AD87

ITEM	QTY	FEMALE	MALE	OTHER	APPLICATION
AD12		1/2" ACME	LO-side R-134a	Bulk	R-134a automotive tanks
AD12B	100	1/2" ACME	LO-side R-134a	Bulk	R-134a automotive tanks
AD14	-	-	14mm x 1/4" SAE		R-134a automotive couplers
AD14B	100	-	14mm x 1/4" SAE	Bulk	R-134a automotive couplers
AD18C	-	1/4" SAE	1/8" SAE	w/ valve core	Manifolds, Compressors
AD24	6	-	1/4" SAE x 1/8" MNPT	w/cap & valve core	Manifolds, Compressors
AD24B	100	-	1/4" SAE x 1/8" MNPT	Bulk	1/4" Service Manifolds
AD36	1	3/16" SAE	1/4" SAE	w/ valve core	TLVC Valve Core Tool for R-12 Auto. HI-side
AD36C	-	3/16" SAE	1/4" SAE	w/ valve core	-
AD41	1	3/4" -14	1/4" SAE	-	Large 125 lb cylinders
AD41B	100	3/4" -14	1/4" SAE	Bulk	Large 125 lb cylinders
AD61	1	3/4" -14	3/8" SAE		Large 125 lb cylinders
AD61B	100	3/4" -14	3/8" SAE	Bulk	Large 125 lb cylinders
AD44	6	-	1/4" SAE x 1/4" MNPT	w/cap & valve core	Vacuum Pumps, Compressors
AD44B	100	-	1/4" SAE x 1/4" MNPT	Bulk	Vacuum Pumps, Compressors
AD47	1	-	1/4" SAE X 1/4" SAE	-	1/4" Hose Union
AD47B	100	-	1/4" SAE X 1/4" SAE	Bulk	1/4" Hose Union
AD48	3	1/4" SAE	1/2" ACME	-	Vacuum Pumps/Manifolds/Recovery/Tanks
AD48B	50	1/4" SAE	1/2" ACME	Bulk	Vacuum Pumps/Manifolds/Recovery/Tanks
AD48C	300	1/4" SAE	1/2" ACME	no valve core	Vacuum Pumps/Manifolds/Recovery/Tanks
AD68	3	1/4" SAE	3/8" SAE	-	Vacuum Pumps
AD68V	-	1/2" ACME	3/8" SAE	male adapter	Vacuum Pumps
AD78	1	1/4" SAE	1/2"-20 UNF	w/core & Depressor	R-410A International
AD78B	100	1/4" SAE	1/2"-20 UNF	w/core & Depressor Bulk	R-410A International
AD81	1	3/4" -14	1/2" ACME	-	Large 125 lb cylinder
AD81B	100	3/4" -14	1/2" ACME	Bulk	Large 125 lb cylinder
AD84	3	1/2" ACME	1/4" SAE	-	Vacuum Pumps/Manifolds/Recovery/Tanks
AD84B	100	1/2" ACME	1/4" SAE	Bulk	Vacuum Pumps/Manifolds/Recovery/Tanks
AD84C	3	1/2" ACME	1/4" SAE	w/Core	Vacuum Pumps/Manifolds/Recovery/Tanks
AD87	1	1/2"-20 UNF	1/4" SAE	w/core & Depressor	R-410A International
AD87S	1	1/2"-20 UNF SWVL	1/4" 55° SAE	w/core & Depressor	R-410A International
AD149C	1	1/4" SAE	1/4" 90°SAE	adapter w/ valve core	-
AD369C	1	3/16" SAE	1/4" 90°SAE	adapter w/ valve core	-
AD849C	3	1/2" ACME 90°	1/4" SAE	w/Core	Vacuum Pumps/Manifolds/Recovery/Tanks
ADGM		R-12 GM POSI-SEAL ADAPTER			
ADK12		DELUXE PRO-SET R-12 ADAPTER KIT			

see page 50 for automotive adapters



VALVE CORE TOOLS

Quick Seal O-Ring Caps & Valve Cores

ITEM	Qty./Pk.	Description
AVC134C	2	1/2" ACME Brass Caps w/Chain
AVC134CB	100	1/2" ACME Brass Caps w/Chain (BULK)
AVC134H	10	R-134a HI Side Caps
AVC134HB	100	R-134a HI Side Caps
AVC134L	10	R-134a LO Side Caps
AVC134LB	100	R-134a LO Side Caps
AVC134PS	2	1/2" ACME Plastic Cap w/ Straps
AVC134PSB	100	1/2" ACME Plastic Cap w/ Straps
AVC2	10	1/4" Aluminum Term Caps
AVC3	10	3/16" Aluminum Term Caps
AVC3P	10	3/16" Plastic Caps
AVC3PB	10	3/16" Plastic Caps
AVC410	10	1/2"-20 UNF SAE Brass Caps
AVC410B	100	1/2"-20 UNF SAE Brass Caps
AVC410C	2	1/2" -20 UNF SAE Brass Caps w/ Chain
AVC410CB	100	1/2" -20 UNF SAE Brass Caps w/ Chain (BULK)
AVC4	10	1/4" SAE Brass Caps
AVC425	25	1/4" SAE Brass Caps
AVC4B	100	1/4" SAE Brass Caps Bulk
AVC4C	2	1/4" SAE Brass Caps w/ Chain
AVC4CB	100	1/4" SAE Brass Caps w/ Chain (BULK)
AVC4P	6	1/4" SAE Plastic Caps
AVC4PB	100	1/4" SAE Plastic Caps
AVC6C	2	3/8" SAE Brass Caps w/ Chain
AVC6CB	100	3/8" SAE Brass Caps w/ Chain (BULK)

ITEM	Qty./Pk.	Description
AVC8C	2	1/2" SAE Brass Caps w/ Chain
AVC8BC	100	1/2" SAE Brass Caps w/ Chain (BULK)
AVC4PS	6	1/4" SAE Plastic Caps w/ Straps
AVC4R	6	1/4" SAE Brass Caps w/ Core Remover
AVC4RB	100	1/4" SAE Brass Caps w/ Core Remover Bulk
AVC6P	3	3/8" SAE Plastic Caps
AVLP	1	Univ. Line Tap Valve 3/16" - 3/8" O.D.
AVS1	10	Valve Cores
AVS1V	6	Valve Cores- 6pk. w/ 1 Brass Cap in Vial
AVS125	25	Valve Cores
AVS1B	100	Valve Cores Bulk
AVS1BC	1000	Valve Cores Bulk
AVS2	10	GM Large Bore Valve Core
AVS3	10	JRA 6mm Valve Cores

NEW!

AVS1V - VALVE CORE KIT
Handy pocket sized kit includes a valve core remover/installer and 6 premium 1/4" valve cores all packaged in a small clear plastic tube.

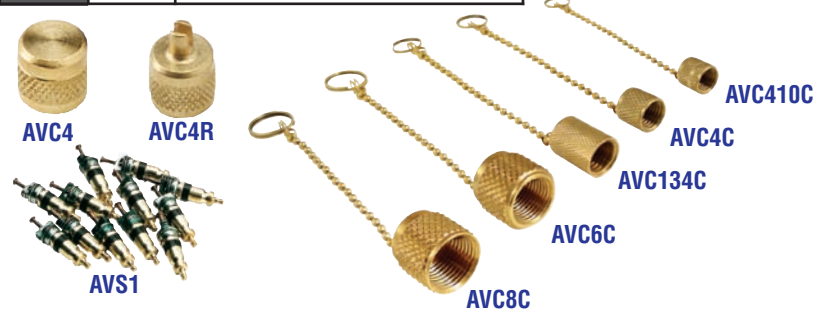

Valve Core Tool Accessories

ITEM	DESCRIPTION
TLVC	1/4" SAE Remover & Installer
TLVCS	1/4" SAE valve core remover & installer w/side port
TLVC1	Standard Valve Core w/3 cores
TLVC2	Dual Valve Core Standard & Large Bore Remover/Installer
TLVC2B	Dual valve core tool (Bulk 100pk)
TLVC4	Valve Core Remover/Installer with Port Rethreader
TLVC6	JRA 6mm Valve Core Remover/Installer
TLVC134	R-134a Valve Core Remover & Installer
TLVC410	1/2"-20 UNF Remover/Installer
TLVCS410	1/2"-20 UNF Valve Core Remover/Installer w/side port
TLVC810	EATON 8 & 10mm Valve Core Remover/Installer
TLXVCBC	Broken Schrader Extractor Tool for TLVC/TLVCS
TLXVCRT	Schrader Rethreading Tool for TLVC/TLVCS
TLXVCT	Digital Thermometer Accessory for TLVC/TLVCS
TLXVC410BC	Broken Schrader Extractor Tool for TLVC410/TLVCS410
TLXVC410RT	Schrader Rethreading Tool for TLVC410/TLVCS410

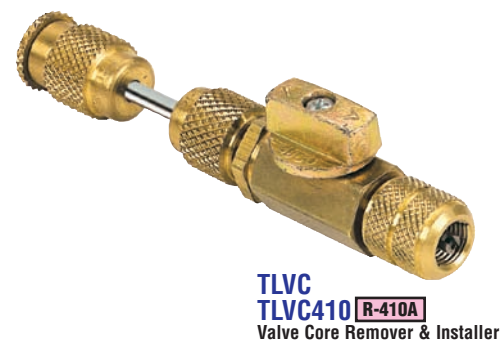
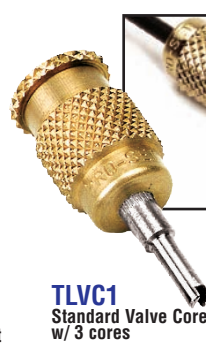
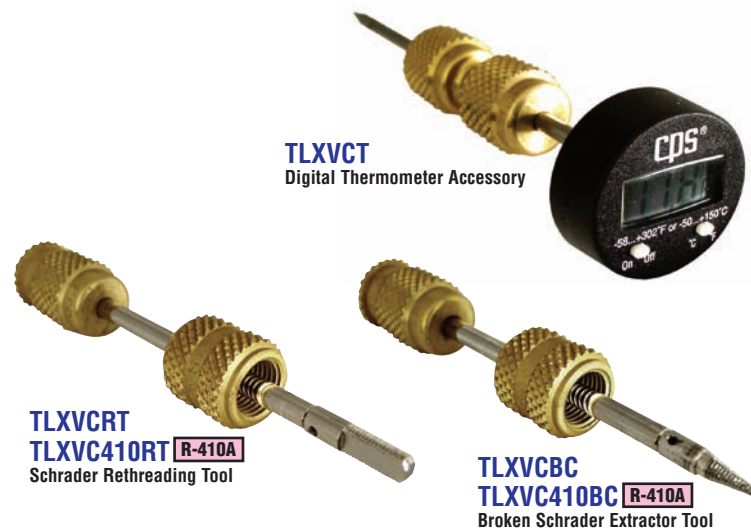



ACCESS FITTINGS

HVAC/R Access Fittings



- Includes Wrench Cap
- For Use with all Refrigerants
- Valves Meet ARI Standard 720-97

AVS44 - 3PK
1/4" M with cap and core x 1/4 F swivel

- Extension length approx. 2"
- Material is CDA 360 Brass & Standard Refrigeration Tubing

Standard Cap		Description	Wrench Cap	
6pk	100pk		6pk	100pk
AV2	AV2B	1/8" O.D. x 1/16" I.D.	AV2R	AV2RB
AV2P	AV2PB	1/8" MPT x 1/4" I.D.	N/A	N/A
AV3	AV3B	3/16" O.D. x 1/8" I.D.	AV3R	AV3RB
AV4	AV4B	1/4" O.D. x 3/16" I.D.	AV4R	AV4RB
	AV4BU	1/4" O.D. x 3/16" I.D. UNASSMBLD	N/A	N/A
AV4L	AV4LB	1/4" O.D. x 3/16" I.D. W/4" COP-TB EXT	AV4LR	AV4LRB
AV4P	AV4PB	1/4" MPT x 1/4" I.D. SOL	N/A	N/A
AV5	AV5B	5/16" O.D. x 1/4" I.D.	AV5R	AV5RB
AV6	AV6B	3/8" O.D. x 5/16" I.D.	AV6R	AV6RB
AV6MM	AV6MB	6mm O.D. x 5mm I.D.	AV6MR	AV6MRB
AV4410	AV4410B	1/2"-20 ACCES, 1/4" O.D. X 3/16" I.D.	N/A	N/A
AV46M	AV46MB	6mm O.D. x 1/4" O.D.	N/A	N/A

1/4" SAE Brass Bodies /Multi-Step Access Valves

AVB34 - 6PK
AVB34B - 100PK
3/16" ID x 1/4" OD



AVB346 - 6PK
AVB346B - 100PK
AVB346BU - 100PK unassbld
AVB346RB - 100PK cap w/core tool
3/16" ID x 1/4" OD x 3/8" OD



AVB46 - 6PK
AVB46B - 100PK
1/4" ID x 3/8" OD



AVB456 - 6PK
AVB456B - 100PK
1/8" ID x 3/16", 1/4", 5/16"



AVB6 - 6PK
AVB6B - 100PK
AVB6BC -100PK w/o caps
6-8-10mm OD Solder



1/4"SAE Tee Connectors



Item	Qty/pk	Description
AVT2P	3	1/4" Male w/Cap & Valve Core x 1/4" Male x 1/8" MNPT
AVT4	3	1/4" Male w/Cap & Valve Core x 1/8" MNPT x 1/4" Male
AVT4B	100	1/4" Male w/Cap & Valve Core x 1/8" MNPT x 1/4" Male
AVT4P	3	1/4" Male w/Cap & Valve Core x 1/4" Male x 1/4" MNPT
AVT4M	3	1/4" Male x 1/8" MNPT x 1/4" Male w/Core
AVT44	3	1/4" Female Hex x 1/4" SAE male x 1/4" male w/Cap & Valve Core

Item	Qty/pk	Description
AVT45	3	1/4" Male x 1/4" Female Knurl x 1/4" Male
AVT48	1	1/4" Male x 1/4" Female Knurl x 1/2" Acme Male
AVT64	3	1/4" Male w/Cap & Valve Core x 1/4" Male x 1/4" Female Hex
AVT64B	100	1/4" Male w/Cap & Valve Core x 1/4" Male x 1/4" Female Hex
AVT87	1	1/4" Male x 1/2"-20 UNF Female x 1/2"-20 UNF Male (R-410A)

1/4" SAE Access Valve With Copper Tube On Branch

Item	Qty./Pk.	Description
AVCT4	3	1/4" SAE x 1/4" O.D.F
AVCT4B	100	1/4" SAE x 1/4" O.D.F
AVCT5	3	1/4" SAE x 5/16" O.D.F
AVCT6	3	1/4" SAE x 3/8" O.D.F
AVCT8	3	1/4" SAE x 1/2" O.D.F

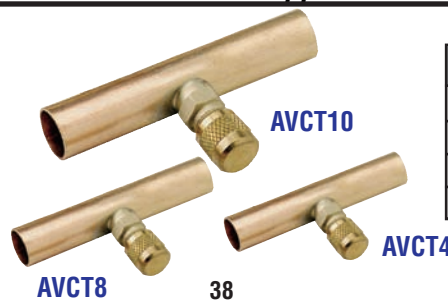

Item	Qty/pk	Description
AVCT10	1	1/4" SAE x 5/8" O.D.F
AVCT12	1	1/4" SAE x 3/4" O.D.F
AVCT14	1	1/4" SAE x 7/8" O.D.F
AVCT18	1	1/4" SAE x 1-1/8" O.D.F



PRO-SET®

TUBING TOOLS

PRO-SET® Tube Cutters

Premium ratchet feedtube cutter



TC206
Capacity
3/8" to 2-5/8" O.D.

Ratchet feed mechanism speeds up cutting operation.

Premium tube cutter



TC274
Capacity
1/8" to 1-1/8"
4mm to 28mm

Smooth Operation provides consistent clean cuts.

Premium Cutting Wheel Top grade steel for easy cutting and longer life.

Heavy duty tube cutter



TC312
Capacity
1/4" to 1-5/8"
7mm to 41mm

Retractable Reamer

Fold away, steel reamer tool with turned cutting edge removes inside burrs. Filing surface removes outside burrs.

Spare Cutting Wheel Located under retractable locking reamer.

Big mini tube cutter



TC174
Capacity
3/8" to 1-1/8"
9.5mm to 28mm

Wide Flare Cut-off Groove to accommodate flares on large size tubing.

Clearance

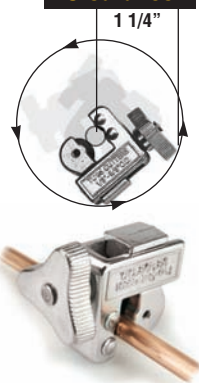

Mini tube cutter

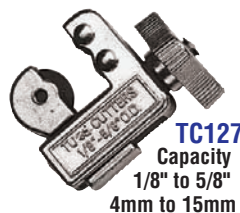

TC127
Capacity
1/8" to 5/8"
4mm to 15mm

Oversized Turning Wheel Designed and approved by the service technician for a sure comfortable grip.



PRO-SET® Tube Cutters

Capillary tube cutter



TCAP

Tube cutter



TC100

ITEM	DESCRIPTION
TC127	Mini Tube Cutter - 1/8" - 5/8", 4 - 15 mm
TC174	Big Mini Tube Cutter 3/8" - 1 1/8", 9.5 - 28 mm
TCX7C	TC127 Cutting Wheel- (10 PK)
TCX7S	TC127 Cutting Wheel Screw- (10 PK)
TC274	Tube Cutter 1/8" - 1 1/8", 4 - 28 mm
TC312	Heavy Duty Tube Cutter 1/4" to 1 5/8", 7 to 41 mm
TCX4C	TC274 / 312 Cutting Wheel- (10 PK)
TCX4R	TC274 / TC312 Reamer Blade
TCX4RS	TC274 / TC312 Reamer Blade Screw
TCX4S	TC274 / TC312 Cutting Wheel Screw- (10 PK)
TCAP	Capillary Tube Cutter
TCSET	TC127 / TC274 Tubing Cutter Set
TC100	Tube Cutter - 1/4" - 7/8". 6 - 23mm
TCX4CS	Cutting Wheel and Screw for TC274 / TC312
TCX7CS	Cutting Wheel and Screw for TC127
TCX100CS	Cutting Wheel and Screw for TC100
TCX4CTS	Titanium Cutting Wheel and Screw for TC206
TCX6CTS	Titanium Cutting Wheel and Screw for TC206
TCX7CTS	Titanium Cutting Wheel and Screw for TC127



TUBING TOOLS

PRO-SET® Tube Benders



TB250
 Universal ratchet tube bender
 for soft copper, aluminum,
 and light wall hydraulic tubing
 from 3/8" to 7/8"
 Sizes: 1/4", 3/8", 1/2", 5/8",
 3/4", 7/8" (6, 8, 10, 12, 16, 19, 22mm)

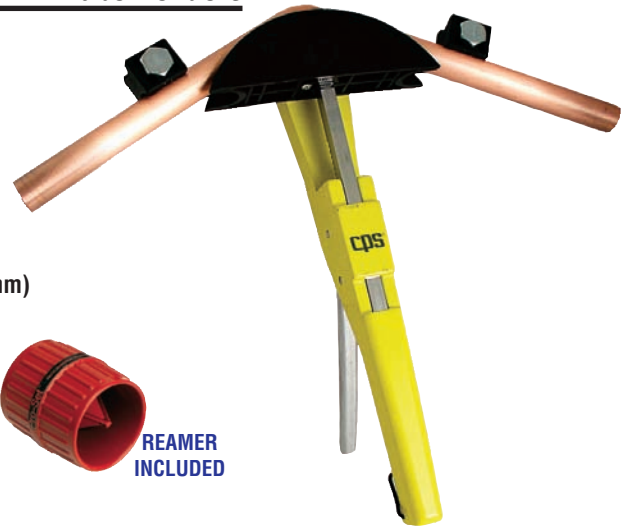

TC274



REAMER INCLUDED

ITEM	DESCRIPTION
TB04	1/4" Tube Bender
TB05	5/16" - 8 mm Tube Bender
TB06	3/8" Tube Bender
TB08	1/2" Tube Bender
TB10	3/4" Tube Bender
TB12	5/8" Tube Bender
TB14	7/8" Tube Bender
TB250	Universal Tube Bender, TC274, Reamer
TB368	Universal Tube Bender 1/4"-5/16"-3/8" 6-8-10 mm
TB6MM	6 mm Tube Bender
TB10MM	10 mm Tube Bender
TB12MM	12 mm Tube Bender
TB15MM	15 mm Tube Bender
TB16MM	16 mm Tube Bender
TB10XH	TB10 Replacement Hook with Screw
TB12XH	TB12 Replacement Hook with Screw
TBS04	1/4" Spring Tube Bender
TBS05	5/16" Spring Tube Bender
TBS06	3/8" Spring Tube Bender
TBS08	1/2" Spring Tube Bender
TBS10	5/8" Spring Tube Bender
TBS12	3/4" Spring Tube Bender

ITEM	REPLACEMENT ACCESSORIES
TBxB1	Small Bending Bar
TBx2	Large Bending Bar
TBXM10	Mandrel 3/8" / 10MM
TBXM14	Mandrel 1/2" / 14MM
TBXM16	Mandrel 5/8" / 16MM
TBXM19	Mandrel 3/4" / 19MM
TBXM22	Mandrel 7/8" / 22MM
TBXM6	Mandrel 1/4" / 6MM
TBXM8	Mandrel 5/16" / 8MM
TBXR	Ratchet Mechanism

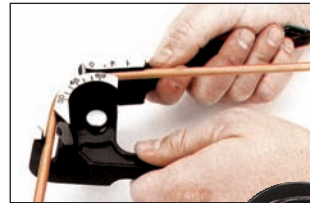

MULTIPLE BENDING CHANNELS
 Compact and Durable Tool With
 Multiple Bending Capabilities

TB368
 Universal Tube
 Bender



TB10
 5/8" Tube
 Bender

TB04
 1/4" Tube
 Bender



TB08
 1/2" Tube
 Bender

TBS04
 1/4" Spring Tube Bender
TBS10
 5/8" Spring Tube Bender



cps®

PRO-SET®

TUBING TOOLS

PRO-SET® Flaring & Swaging Tools



FT500

FEATURES OF THE FT500

- Slot in yoke is used for tube height gauge.
- Sliding dies with lever clamping action.
- Yoke slips over top of bar, then locks into position with slight turn.

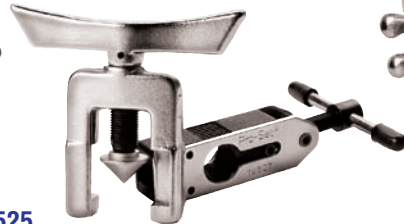

FT525
Universal/ Adjustable Flaring Tool
3/16" to 5/8" (5mm to 16mm)



FT195
45° Flaring Tool
3/16" to 5/8"

FT203
Flaring Tool
5/8", 3/4", 7/8",
& 1 1/8" O.D

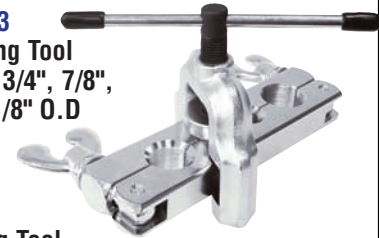

FT800FN

PRO-SET®

FT800FN R-410A

- Engineered specifically to create stronger flare joints for higher pressure R-410A systems.
- Unique clutch driven feed screw and eccentrically mounted cone produces uniform, clean flare walls without galling.
- Exclusive 3/8"sq drive incorporated directly in yoke handle for use with ratchet (included).
- Rugged polyethylene storage case included.

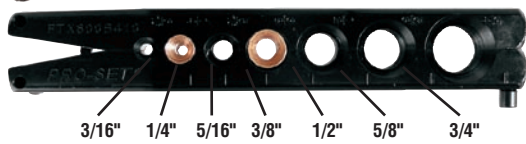

3/16" 1/4" 5/16" 3/8" 1/2" 5/8" 3/4"

Also Available FT806A / FT806M



FS275
45° Flaring & Swaging Kit
1/8" - 3/4"

PRO-SET® Flaring Tools, Kits, Replacement Parts

**All flaring tools listed are recommended for softer thin-walled materials such as copper, aluminum, and brass*

ITEM	DESCRIPTION
FS226	Tube Cutting/Double Flaring Set 1/8" - 3/4"
FS226M	Metric Tube Cutting/Double Flaring Set 4.75, 6, 8, 10mm
FS275	45° Flaring & Swaging Kit 1/8" - 3/4"
FS275M	45° Flaring & Swaging Kit Metric
FSX501	FS275 Bar 7/16", 1/4", 1/8", 3/16", 5/16", 3/8"
FSX502	FS275 Short Bar 1/2", 5/8", 3/4" O.D
FSX503	FS275 5/16" Swaging Adapter
FSX504	FS275 3/16" Swaging Adapter
FSX505	FS275 1/2" Swaging Adapter
FSX506	FS275 5/8" Swaging Adapter
FSX507	FS275M 8, 12, 14, 16, 22 MM Swaging Adapter
FSX508	FS275 3/4" Swaging Adapter
FSX509	FS275 Yoke Assembly
FSX511	FS275M 15, 16mm Flaring Bar Metric
FSX512	FS275M 4, 18, 22mm Flaring Bar Metric
FSX513	FS275 Compressor Cone
FT195	45° Flaring Tool 3/16" to 5/8"
FT500	45° Flaring/Burning Tool Metric 3/16" TO 5/8"
FT500M	45° Flaring/Burning Tool Metric 6mm to 16mm
FT525	Adjustable Flaring Tool 3/16" to 5/8"/ 5 to 16mm

ITEM	DESCRIPTION
FT800FN	R-410A Imperial Concentric Flaring Tool w/Ratchet 3/16", 1/4", 5/16", 3/8", 1/2", 5/8", 3/4"
FT806A	Imperial Eccentric Flaring Tool w/Ratchet 3/16", 1/4", 5/16", 3/8", 1/2", 5/8", 3/4"
FT806M	Metric Eccentric Flaring Tool w/Ratchet 6, 8, 10, 12, 15, 16, 18mm
FTX500	FT195 Yoke Assembly
FTX501	FT195 Flaring Bar 5/16", 3/8", 7/16"
FTX509	FT195 Compressor Cone
FTX510	FT195 Wing Nut
FTX513	FT500 Yoke Assembly
FTX514	FT500 Die Holder Assembly
FTX515	FT500M Die Holder Assembly
FTX516	FT525 Yoke Assembly
FTX517	FT525 Tube Holding Assembly
FTX518	FS275 Yoke Assembly
FTX800B410	FT800FN R410A Imperial Flaring Bar
FTX800BA	FT806A Imperial Flaring Bar
FTX800BM	FT806M Metric Flaring Bar
FTX800R	Ratchet for FT800FN/FT806A/FT806M
FTX800Y	Yoke Assembly FT800FN/FT806A/FT806M



TUBING TOOLS

PRO-SET® Tube Expander/Swaging Set



TLE6/TLE6M (metric)

- Create professional grade one seam pipe unions in the field.
- Multi-faceted interchangeable heads ensure equal linear expansion of tubing and uniformed wall thickness.
- Extended handle length provides added leverage for ease of operation.
- Re-round deformed tubing and fabricate couplings.
- Components are heat treated for durability.
- Ideal for copper, aluminum and soft steel tubing.
- Includes storage case for long-term protection.

Accessory Heads

Imperial

Model	Size
TLE6	Tube expander set with 6 heads 3/8", 1/2", 5/8", 3/4", 7/8", 1 1/8"
TLE6M	Tube expander set with case includes: 10, 12, 15, 18, 22, 28mm
TLE601	Expander tool only
TLH06	3/8" Expander Head (Standard in TLE6)
TLH08	1/2" Expander Head (Standard in TLE6)
TLH10	5/8" Expander Head (Standard in TLE6)
TLH12	3/4" Expander Head (Standard in TLE6)
TLH14	7/8" Expander Head (Standard in TLE6)
TLH16	1" Expander Head
TLH18	1 1/8" Expander Head (Standard in TLE6)
TLH22	1 3/8" Expander Head
TLH26	1 5/8" Expander Head

Metric

Model	Size
TLHM10	10mm Expander Head (Standard in TLE6M)
TLHM12	12mm Expander Head (Standard in TLE6M)
TLHM15	15mm Expander Head (Standard in TLE6M)
TLHM16	16mm Expander Head
TLHM18	18mm Expander Head (Standard in TLE6M)
TLHM20	20mm Expander Head
TLHM22	22mm Expander Head (Standard in TLE6M)
TLHM28	28mm Expander Head (Standard in TLE6M)
TLHM35	35mm Expander Head
TLHM42	42mm Expander Head



PRO-SET® Metric Torque Wrench Set



TLTWSM

Professional interchangeable jaw torque wrench set ensures compliance with OEM torque settings for high pressure **R-410A** systems.

- Interchangeable 17, 22, 24, 26, 27 & 29mm jaw sizes.
- Corresponding settings clearly marked on torque wrench in Newton Meters (10-75Nm).
- Provides consistently accurate readings and rugged, trouble free performance.
- Includes storage case for long-term protection.
- 1 year product warranty.

PRO-SET® Deburring Tools /Universal Reamer Tool



TLDB2 - Pocket Deburring Tool

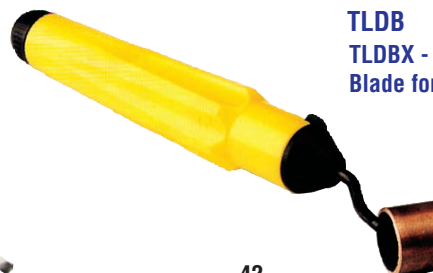

**TLDB
TLDBX - Replacement Blade for TLDB**



TLRM

cps[®]

PRO-SET[®]

SPECIALTY HAND TOOLS

PRO-SET[®] 6-in-1 Auto-Loading Screwdriver



TLSD1

- Patented auto loading bit design
- 6 replaceable industrial grade 1/4" hex bits
- Includes standard valve core tool bit
- Magnetic head holds fastener in place
- Ergonomic high impact housing design
- Standard 1/4" hex drive



A
Pull handle back to return bit to storage chamber



B
Rotate handle to select bit



C
Push handle forward to load bit



PRO-SET[®] Specialty Hex Key Wrench Sets



TLSWH

Inch Hex Key Set:
3/32", 7/64", 1/8",
9/64", 5/32", 3/16",
7/32" and 1/4"
(Nickel Plated Finish)

*TLSWHB Two Piece Set:
Includes TLSWH and TLSSWB



TLSSWB

Inch Ball Point Key Set:
3/32", 7/64", 1/8", 9/64",
5/32", 3/16", 7/32"
and 1/4"
(Nickel Plated Finish)

*TLSWHB Two Piece Set:
Includes TLSWH and TLSSWB



TLSWHM

Metric Hex Key Set:
1.5, 2, 2.5, 3, 4,
5, 6, 8mm
(Nickel Plated Finish)



TLSSWT
Torx Wrench Set

PRO-SET[®] Swaging / Pinch-Off Tools

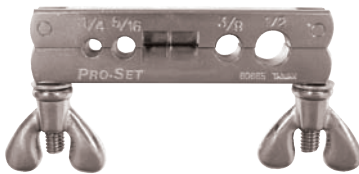

TLPORR

Pinch-Off tool & rerounds tubing on
1/4", 5/16", 3/8", and 1/2"
Copper and tubing



TLPK
Swage Punch Tool



TLMSP

Multi Swage Punch Tool
6 sizes- 3/16" to 5/8"

PRO-SET[®] Service Pliers



TLPO

Pinch-Off Pliers



TLPP

Tube Piercing Pliers 1/4"



TLPPX
Replacement tip for TLPP

PRO-SET[®] Service Wrenches

127 Offset Wrench
3/8" - 5/16" x 1/4"
- 3/16" Sq.

TLSWO



127 Service Wrench
3/8" - 5/16" x 1/4"
- 3/16" Sq.

TLSWS



124 Service Wrench
1/4" - 3/16" SQ x 9/16"
1/2" HEX

TLSWL





SPECIALTY HAND TOOLS

Fin Straightening Tools

TLFC1
Metal Fin
Straightening Tool



TLFC2
Fin Straightener
with large handle



TLFC6
Universal 6 Sided
Fin Straightening Tool
Repair bent condenser fins
with the TLFC6 Universal 6
sided fin comb straightening
tool.

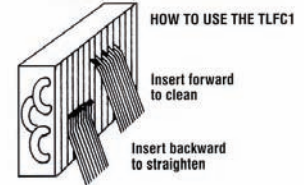
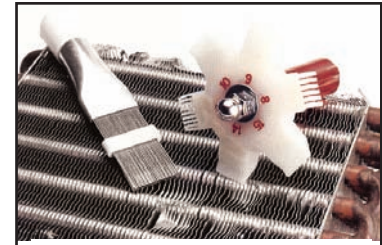

PRO-SET® Inspection Mirrors



TLMIR1

TLMIR2

TLMIR3

TLMIR4

ITEM	DESCRIPTION
TLMIR1	Circular Telescoping Pocket Mirror ø 1.25"
TLMIR2	Circular Telescoping Mirror ø 2.24"
TLMIR3	Rectangular Telescoping Mirror 3.5 x 2.12"
TLMIR4	Oval Pocket Mirror 2 x .98"
TLXMIR1	Replacement Mirror Head for TLMIR1
TLXMIR2	Replacement Mirror Head for TLMIR2
TLXMIR3	Replacement Mirror Head for TLMIR3
TLXMIR4	Replacement Mirror Head for TLMIR4

Solenoid Magnet

The **TLMKC18** is designed to manually open solenoid valves by magnetically lifting the stem assembly and plunger. Simply slide the TLMKC18 over the valve's enclosing tube and the industrial grade magnets incorporated inside the rugged ABS plastic housing does the rest. It is an ideal tool for trouble shooting/servicing both direct connected or pilot operated 2-way solenoid, 3-way reclaim or 4-way reversing valves.

* 0.75"/18mm opening fits all common manufactured valves



TLMKC18

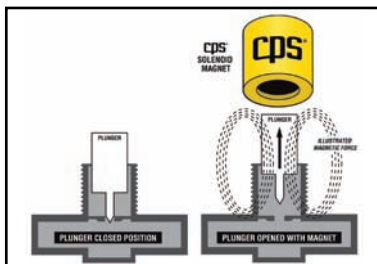

Compact Magnetizer/Demagnetizer

Use the **TLMAG1** to magnetize tools in order to keep small screws and nuts in position, especially helpful when working in confined spaces, or demagnetize tools when working on or near electronic circuit boards. Simply insert a screwdriver or nut driver into the (+) opening, slowly draw it out and it's magnetized. Leave the magnetizer on the tool for extra strength. To demagnetize, slowly draw the tool through the smallest area of the (-) opening. The TLMAG1 is an essential tool for the professional and do-it-yourselfer alike.

- Instantly Magnetize or Demagnetize Steel Tools & Parts
- Incorporates Two C5 Industrial Strength Magnets
- Impact Resistant ABS Molded Plastic
- No Batteries or Electricity Required
- Compact Design: 2" x 2" x 1"



TLMAG1





SPECIALTY HAND TOOLS

Composite Handle Adjustable Wrench

Super-strong tool that exceeds ANSI specifications providing years of service.



TLWA06
Size: 6"
Jaw Capacity:
15/16" / 24mm

TLWA08
Size: 8"
Jaw Capacity:
1 1/8" / 29mm

TLWA10
Size: 10"
Jaw Capacity:
1 5/16" / 33mm

TLWA12
Size: 12"
Jaw Capacity:
1 1/2" / 38mm

- Patented Light Weight Composite Handle Design
- Ergonomic, Comfortable Grip Reduces Fatigue
- Wide Jaw Opening With 45% More Torque
- Precision Machined for Smooth Operation
- Durable and Environment-Resistant
- One Year Warranty

Duct Knives

Used to fabricate fiberglass duct board. Stainless steel double edge resharpenable blade facilitates easy piercing for inside cuts. The double edge is also ideal for tapping into and trimming flex duct. Available with either ergonomic cushioned or a comfortable walnut wooden handle.

A double edge also ideal for tapping into and trimming flex duct.



TLDKRH
6" (152 mm.)

TLDKWH
6" (152 mm.)
Net Weight: 5 oz. (142 g.)



Rechargeable Anodized Aluminum LED Work Light

Simply the best work light you will ever own, the **TLWL53A** is precision machined from aircraft grade aluminum and anodized for long life. Fifty three proprietary high output LEDs are incorporated in the work light segment with a 1W Luxeon LED integrated in the top. A powerful 2500mAh Ni-Mh rechargeable battery keeps the lights burning for hours; 7-8 hours for Luxeon spot, 4-5 hours for 53 white LEDs. The professional quality and intense output of the TLWL53A outperforms many competitive units incorporating 70 or more standard LEDs. Ideal for air conditioning contractors municipalities, law enforcement, fire fighters, automotive technicians, and wherever else a high performance, professional, durable work light is needed.

MOONLIGHT™

- Rugged Anodized Aluminum Body
- Super Bright 1W Luxeon Spot
- 53 Proprietary High Lumen Output LEDs
- Integrated 2500mAh 3.5V Rechargeable Battery
- Strong magnetic base for attaching to metal surfaces
- Universal UL/CUL Electronic Wall and Car Chargers Included
- Superior Durability and Shock Resistance
- High Quality Reflector Lens
- One Year Warranty
- Wall and Car charger Included



TLWL53A



Super Bright 1W Luxeon Spot

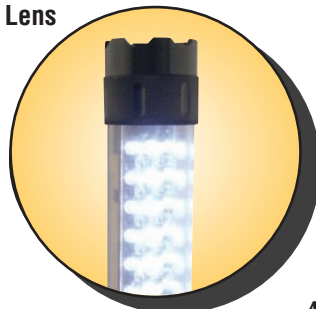

53 Proprietary High Lumen Output LEDs



Strong magnetic base for attaching to metal surfaces

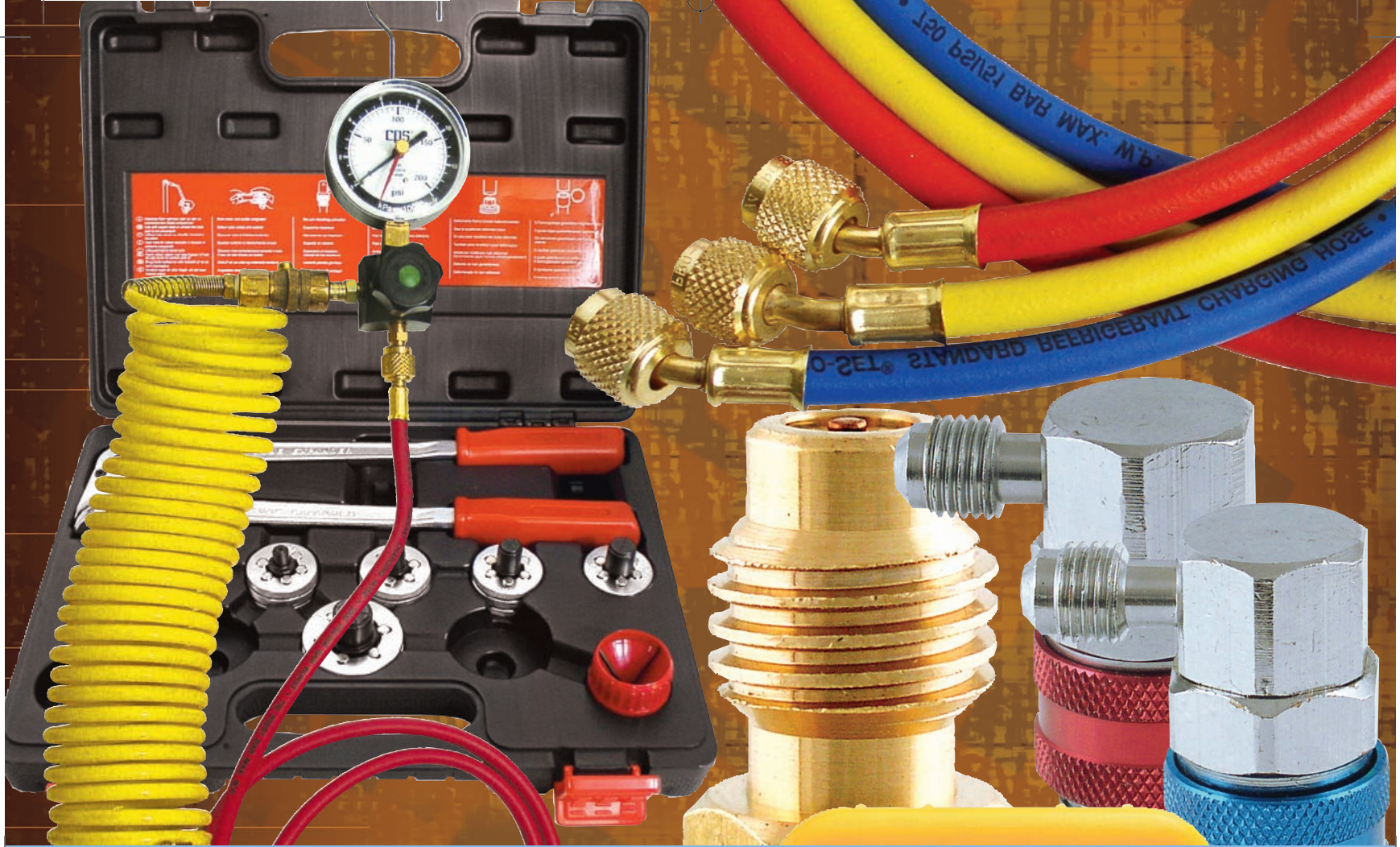

AUTOMOTIVE SECTION

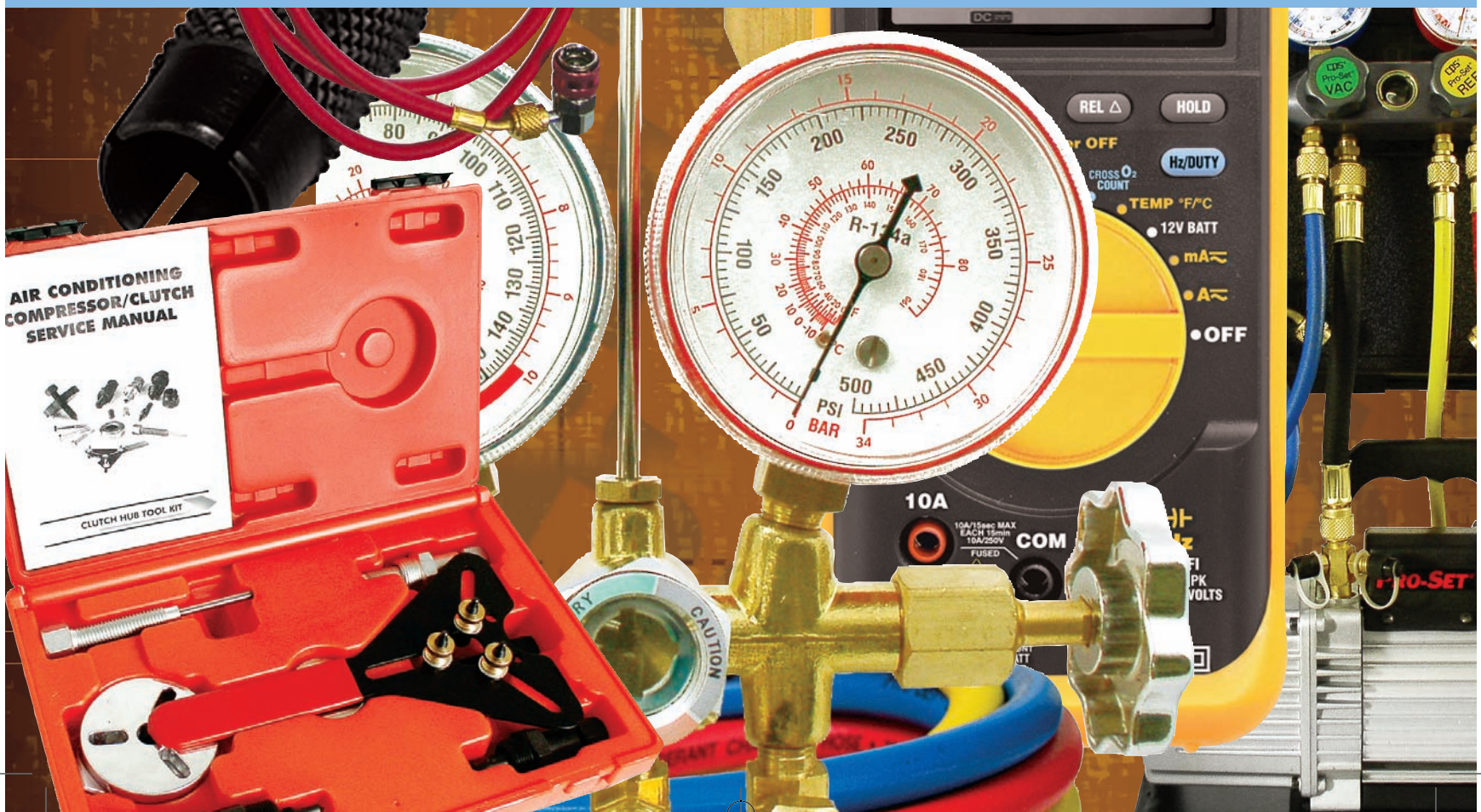



AUTOMOTIVE

SERVICE MANIFOLDS

Automotive Two Valve Manifolds with 1/2" ACME FITTINGS

1/2" ACME Fittings on Manifold, 1/2" ACME X 14mm Fittings on Hoses & 14mm couplers

Gauge Description	Refrigerant Scales	R134a, R404A, R407C	R134a, R404A, R22, R407C	R134a
	Diameter	68mm	80mm	80mm
	Pressure Scales	BAR/PSI	BAR/PSI	BAR/PSI
	Accuracy	Class 1.6	Class 1.6	Class 1.0
	Temperature Scales	°C	°C	°C
Rplmt. Gauges	High Side	RGFH	RGJH	RGLH
	Low Side	RGFL	RGJL	RGLL
Rplmt. Gauges	High Side w/ Rubber Boot	RGFHB	RGJHB	RGLHB
	Low Side w/ Rubber Boot	RGFLB	RGJLB	RGLLB
Two Valve Vortech Manifold	Manifold & Gauges Only	MV7F	MV7J	MV7L
	180cm Hoses w/14mm Prem. Couplers	MV7FA6Q	MV7JA6Q	MV7LA6Q
	w/ Carry Case	MV7FA6QC	MV7JA6QC	MV7LA6QC
	240cm Hoses w/14mm Prem. Couplers	MV7FA8Q	MV7JA8Q	MV7LA8Q
	w/ Carry Case	MV7FA8QC	MV7JA8QC	MV7LA8QC
Two Valve BlackMax Manifold	Manifold & Gauges Only	MAF	N/A	N/A
	180cm Hoses w/14mm Snap Couplers	MAFA6K	N/A	N/A
	240cm Hoses w/14mm Snap Couplers	MAFA8K	N/A	N/A
	w/ Carry Case	MAFA8KC	N/A	N/A

VORTECH®



BLACKMAX™





AUTOMOTIVE

SERVICE MANIFOLDS

DUAL AUTOMOTIVE TWO VALVE MANIFOLDS
 1/4" SAE Fittings on Manifold, Hoses & Couplers

Gauge Description	Refrigerant Scales	R134a, R404A, R407C	R134a, R404A, R22, R407C	R134a
	Diameter	68mm	80mm	80mm
	Pressure Scales	BAR/PSI	BAR/PSI	BAR
	Accuracy	Class 1.6	Class 1.6	Class 1.0
	Temperature Scales	°C	°C	°C
Rp.lmt. Gauges	High Side	RGFH	RGJH	RGLH
	Low Side	RGFL	RGJL	RGLL
Rp.lmt. Gauges	High Side w/ Rubber Boot	RGFHB	RGJHB	RGLHB
	Low Side w/ Rubber Boot	RGFLB	RGJLB	RGLLB
Two Valve Vortech Manifold	Manifold & Gauges Only	MV8F	MV8J	MV8L
	180cm Hoses w/1/4" SAE Prem. Couplers	MV8FA6Q	MV8JA6Q	MV8LA6Q
	w/ Carry Case	MV8FA6QC	MV8JA6QC	MV8LA6QC
	240cm Hoses w/1/4" SAE Prem. Couplers	MV8FA8Q	MV8JA8Q	MV8LA8Q
	w/ Carry Case	MV8FA8QC	MV8JA8QC	MV8LA8QC
Two Valve BlackMax Manifold	Manifold & Gauges Only	MDF	N/A	N/A
	180cm Hoses w/1/4" SAE Snap Couplers	MDFS6K	N/A	N/A
	240cm Hoses w/1/4" SAE Snap Couplers	MDFS8K	N/A	N/A
	w/ Carry Case	MDFS8KC	N/A	N/A

VORTECH®



BLACKMAX™





AUTOMOTIVE

CHARGING HOSES & ADAPTER KITS

Automotive Hoses 14mm x 1/2" ACME

LENGTH	YELLOW 1/2" acme x 1/2" acme	BLUE 1/2" acme x 14mm	RED 1/2" acme x 14mm	3-PACK	YELLOW A.B. 1/2" acme x 1/2" acme	3 PACK Anti Blowback
3' - 90cm	HA3Y	HA3B	HA3R	HA3	HA3YA	HA3A
5' - 150cm	HA5Y	HA5B	HA5R	HA5	HA5YA	HA5A
6' - 180cm	HA6Y	HA6B	HA6R	HA6	HA6YA	HA6A
8' - 240cm	HA8Y	HA8B	HA8R	HA8		
10' - 300cm	HA10Y	HA10B	HA10R			
20' - 600cm	HA20Y	HA20B	HA20R			



HXG2 - Replacement 1/2" ACME Gaskets (10)
 HX14R - Replacement 14mm O-Ring (Qty. 10 Red & Blue Hoses Only)
 HXD - Replacement Depressors (Yellow hose only)
 See pg. 34-36 for 1/4" SAE Hoses & Replacement Parts

R-12 to R-134a Automotive Hose Conversion Sets

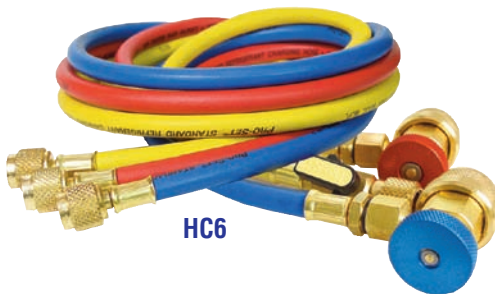

Complete manifold hose set 1/4" SAE x 1/2" ACME 6' w/R-134a couplers
 HC6B- Blue replacement hose
 HC6R- Red replacement hose
 HC6Y- Yellow replacement hose
 QCL134- R-134a low coupler 14mm
 QCH134- R-134a high coupler 14mm

R-12 Automotive Adapter Kit

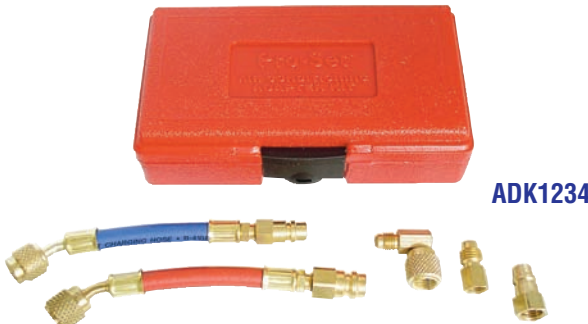

Use your R-134a manifold to check old R-12 systems

R-12 Automotive Flex Hoses

Automotive Flex Hoses

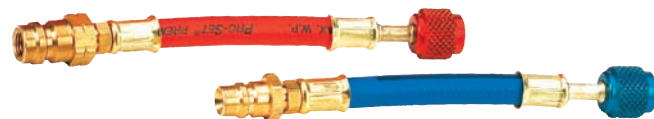

HTAD1	R-12 1/4" SAE Male x 1/4" SAE Female
HTAD2	R-12 1/8" Female x 1/4" SAE Male
HTAD3	R-12 3/16" SAE Female x 1/4" SAE Male

HT134L	R-134a 1/4" SAE Female x R-134a Low
HT134H	R-134a 3/16" SAE Female x R-134a High

Charging Hose Service Parts Kit

Automotive O-Ring Assortment



This assortment contains hose gaskets, valve cores, service port caps, and coupler o-rings. Order the **HXKIT** for both R-134a and R-12.
Replacement parts sold individually: AVS1, AVC3P, AVC4P, AVC134L, AVC134H, HXD, HXD, HX3D, HX4D, HXG, HX14R, QCXR34



The **TLRK** covers the most popular metric and SAE o-rings. A must for today's busy a/c repair shop. 18 sizes with 180 o-rings.

**HNBR & NEOPRENE
 OEM APPROVED**

HXKIT

TLRK



AUTOMOTIVE

BALL VALVES & ANTI-BLOWBACK VALVES

PRO-SET® Ball Valves

MALE x MALE FULL FLOW BALL VALVE



BVM
1/4" SAE Male, 1/4" SAE Male



90° SWIVEL ELBOW x MALE FLOW FLOW BALL VALVE



BVAD90
3/16" SAE Female 90° 1/4" SAE Male 90° FM



PRO-SET®

- Add existing hose to eliminate refrigerant loss and comply with EPA regulations
- Easy 1/4 turn open/close with rugged plastic composite color-coded handles
- Oversized chrome ball for smooth operation and non-restrictive flow
- Individual valves includes all three color-coded handle inserts

Item	Qty / Pk	Female	Male	Other
BV	1	1/4" SAE	1/4" SAE	Straight
BV3	3	1/4" SAE	1/4" SAE	Straight
BV38	1	3/8" SAE	3/8" SAE	Straight
BV12	1	1/2" ACME	1/2" ACME	Straight
BVAD	1	3/16" SAE	1/4" SAE	Straight
BVAD12	1	1/2" ACME	3/8" SAE	Straight
BVAD24	1	1/2" ACME	1/4" SAE	Straight
BVAD38	1	3/8" SAE	1/4" SAE	Straight
BVAD90	3	3/16" SAE 90°	1/4" SAE	90° FM
BVXH	3	Replacement Ball Valve Handle w/1 ea (Yellow, Blue, Red) inserts		

SWIVEL NUT STRAIGHT x MALE FULL FLOW BALL VALVE



BV38
3/8" SAE Female, 3/8" SAE Male



SWIVEL NUT STRAIGHT x MALE FULL FLOW BALL VALVE



BV12
1/2" ACME Female, 1/2" ACME Male



MICROSEAL™ Anti-Blowback Valves

- Advanced automatic sealing valve eliminates refrigerant loss and blowback
- New micro valve technology enables use on systems with limited access to service ports
- Add to existing hose to eliminate refrigerant loss and comply with EPA regulations
- Deep easy grip knurling and non-restrictive porting for maximum refrigerant flow
- Up to 25% smaller O.D. than similar competitive models

Item	Qty / Pk	Female	Male	Other
AB12	1	1/2" ACME	1/2" ACME	Straight

see pg. 35 for additional anti-blowbacks



AB12

Premium R-134a Manual Couplers Meets EPA SNAP rule

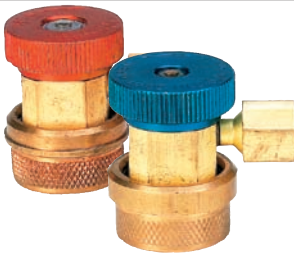

QCH134 SET



These patented couplers include latching balls to provide superior service port alignment, cross pin valve depressor control, and a safety sleeve to prevent accidental refrigerant venting.

QCH134 -high side **QCL134** -low side
QCXR34 -coupler O-rings

STYLE	Manual
SPEC	SAE J-639
THREAD	14mm



QC14 SET



This 1/4" style converts old freon® hoses and manifolds to R-134a. Order the **QC14SET** for R-134a 1/2" Acme systems that require the AD84 tank adapter.

QCH14 -high side
QCL14 -low side

STYLE	Manual
SPEC	SAE J-639
THREAD	1/4" SAE

Standard R-134a Snap Couplers



QC90 SET

Change your old R-12 brass manifold to R-134a with the **QC90SET**. Many A/C injectors use the quick connect snap style for the low side dye/oil application.

QCH90 -high side **QCL90** -low side

STYLE	push on snap
THREAD	1/4" SAE



QC13490 SET

The snap style is designed for mechanics just starting a/c repair.

QCH13490 -high side
QCL13490 -low side
QCXO -coupler O-rings

STYLE	push on snap
THREAD	14mm



AUTOMOTIVE

SPECIALTY HAND TOOLS

PRO-SET® Valve Core Tools

Automotive Refrigerant Can Taps

ITEM	DESCRIPTION	HVAC	AUTOMOTIVE	TRUCK
TLVC	1/4" SAE Remover & Installer	ALL	R-12 Only (use AD36 for 3/16")	R-12 Only (use AD36 for 3/16")
TLVC1	Standard Valve Core w/3 cores	ALL	R-12 & some R-134a	R-12 & some R-134a
TLVC2	Dual Valve Core Standard & Large Bore Remover/Installer	ALL	R-12 & some R-134a	R-12 & some R-134a
TLVC4	Valve Core Remover/Installer with Port Rethreader	ALL	R-12 Only	R-12 Only
TLVC6	JRA 6mm Valve Core Remover/Installer	No	R-134a Cars Made In Japan	R-134a Light Trucks Made In Japan
TLVC810	EATON 8 & 10mm Valve Core Remover/Installer	No	R-134a Cars with 8 & 10mm	R-134a Heavy Duty Trucks with 8 & 10mm
TLVC134	R-134a Valve Core Remover & Installer	No	R-134a systems with standard core	R-134a systems with standard core



3-in-1 Can Tap: R-12, R-134a & oil charge cans Dual 1/4" SAE & 1/2" Acme tee fitting for both R-12 & R-134a. Permanently attached swiveling inserts. Quick change between can types.

TLCT1234



NEW!

AVS1V - VALVE CORE KIT
Handy pocket sized kit includes a valve core remover/installer and 6 premium 1/4" valve cores all packaged in a small clear plastic tube.

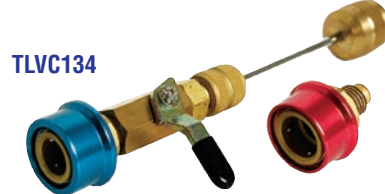

TLVC134

R-134a VALVE CORE REMOVER & INSTALLER

- Fits Hi & Lo service ports with standard size valve cores.
- Built-in ball valve retains charge & allows access to A/C system.
- Excellent for replacing valve cores without discharging the system and for speeding recovery and recharging of large systems.

SIDE CAN TAPS	
TLCT1234	R-12/ R-134a can tap
TLCT12	R-12 Side Can Tapper
TLCT34	R-134a Side Can Tapper
TLCTX34	R-134a Oil Charge Insert
TLCTXG	Side Can Tap Gaskets (10)



TLVC4



TLVC6



TLVC1



TLVC2



TLVC810

PRO-SET® Valve Core Tools



ADGM



AD18C/AD36C



AD149C/AD369C



AD48



AD12



AD14

ITEM	QTY	FEMALE	MALE	OTHER	APPLICATION
AD12	1	1/2" ACME	LO-side R-134a	-	R-134a automotive tanks
AD14	1	-	14mm x 1/4" SAE	-	R-134a automotive couplers
AD149C	1	1/4" SAE 90°	1/4" SAE	w/core & Depressor	Hard-to-access ports
AD18C	1	1/8" SAE	1/4" SAE	w/core & Depressor	R-12 Automotive HI-side
AD36C	1	3/16" SAE	1/4" SAE	w/Cap & Core	R-12 Automotive HI-side
AD369C	1	3/16" SAE 90°	1/4" SAE	w/Cap & Core	R-12 Automotive HI-side
AD48	3	1/4" SAE	1/2" ACME	w/Core	Vacuum Pumps/Manifolds/Recovery/Tanks
ADGM	1	GM Deep Reach	1/4" SAE	w/ Extended Core Depressor	GM R-12 PosiSeal Hi-side 91-94



AUTOMOTIVE

SPECIALTY HAND TOOLS

Compressor Clutch Tool Kit



The **CTK1300A** includes the most popular tools that remove and install clutch hubs. In addition, the universal spanner wrench has been added. The instruction manual covers all specifications for air gap, oil, compressor id, and troubleshooting tips.

Domestic and Imports
Individual tools include CT205, CT305, CT499, CT861, CT867, CT884

CTK1300A

Deluxe Clutch Hub Puller/Inst. Kit



Comprehensive variety of A/C clutch hub pullers and installers for popular A/C compressors such as GM, Ford, Chrysler and imports.

CTK9100

Compressor Clutch Tools

ITEM	COMPRESSOR TYPE	REMOVER	INSTALLER
CT206	Zexel (Diesel Kiki) used with CT305	YES	NO
CT305	Sanden SD 5&7	YES	NO
CT499	Universal Spanner Wrench	YES	YES
CT861	GM R4, A6 SAE	YES	YES
CT867	GM V5, DA6, HR6 Metric	YES	YES
CT884	Ford FS6 /Chrysler C171	YES	YES
	Hitachi MJ /Tecumseh	YES	YES
	Nippondenso 6P /10P	YES	YES



Orifice Tube Tool Kit

R-134a Orifice Tube Tool Kit

Individual Orifice Tube Tools



TLOTK
Includes remover, extender body, damaged tube extractor for 1985-2004 GM, Ford, and import clutch cycling orifice tube systems.



TLK134
The TLK134 is the most complete tool kit on the market for valve core and orifice tube service. Includes an easy to find application chart.



ITEM	DESCRIPTION
TLOT12	GM/Ford remover/installer with evaporator inlet (short)
TLOT18	Ford FOTCC system remover/installer (long)
TLOT19	Orifice tube extractor used with TLOT12 & TLOT18
TLOTK	Universal Orifice Tube Tool Kit with Case
TLK134	R-134a Orifice Tube Tool Kit with Case



AUTOMOTIVE

SPECIALTY HAND TOOLS

Flush Gun kit

PRO-SET® Flaring & Swaging Tools



Reduce comebacks by flushing evaporator & condenser with the **TLFG**. Simply add solvent and use shop air to reverse flush the component. **TLFGXT** - Replacement tip for flush gun.



FS226M

Metric ISO Bubble Flaring For Japanese and European Brake Lines
Tool Kit 4.75, 6, 8, 10 mm

Automotive Service Parts Kit

#1 PRESSURE TESTING PUMP WITH GAUGE NO.2-3 ARE TEST ADAPTERS

#4 ADAPTER – PEUGEOT, MITSUBISHI, NISSAN, MAZDA, TOYOTA SUBARU, INFINITI, GEO, SUZUKI, ISUZU, LEXUS

#5 ADAPTER – HONDA, TOYOTA, SUZUKI, MITSUBISHI

#9 ADAPTER – VW T4, NEW AUDI A4, A5, A6, BMW345

#10 ADAPTER – BMW

#11 ADAPTER – AUDI, VW

#13 ADAPTER – MERCEDES BENZ

#0 TEMPERATURE GAUGE

#3 ADAPTER – MERCEDES BENZ, FORD, GM (BUICK), JEEP

#2 ADAPTER – GM (CADILLAC)

#6 ADAPTER – OPEL, VW, FORD, BMW245, SAAB, JAGUAR

#8 ADAPTER – NEW VW

#7 ADAPTER – VOLVO, SAAB, AUDI, CITRON, RENAULT, FIAT, PEUGEOT, ALFA, JEEP

#12 ADAPTER – FORD, INTERNATIONAL, GM, RANGE ROVER

TLRAD
FEATURES ANODIZED ALUMINUM ADAPTERS!!!

Springlock Coupling Tools

Anodized Aluminum A/C Disconnect Tool Kit



Fits Ford/Jaguar, Chrysler/Jeep & Mitsubishi

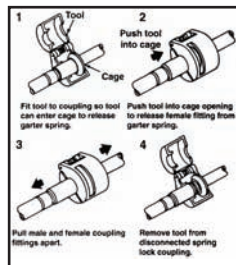

PRO-SET® Deburring Tools /Universal Reamer Tool

Refractometer



TLDB34
R-134a Automotive



TLREF
ANTIFREEZE / BATTERY / CLEANING FLUIDS TESTER
This instrument is designed for testing the concentration of battery fluids, antifreeze liquids and cleaning fluids. The percentage indicator indicates the point of freezing for both propylene glycol and ethylene glycol. It can also be used for checking the strength of electrolyte solution batteries.



AUTOMOTIVE

UV REFRIGERANT LEAK DETECTION

UVPRO UV Flashlight & Enhancing Glasses



Actual Size

UVPRO

Don't forget the "UV" when selecting your next UV light.

Ultra Violet (UV) dye additives are specially formulated to fluoresce in the presence of UV light rays. Hence the common industry names for the two major components used with this technology, "UV" dye and "UV" lights. Referring to the light spectrum chart below you can see that true "UV" light is invisible to the human eye, with the closest visible light colors being purple and blue respectively. The overall intensity of UV light diminishes as you move from the invisible UV light range to purple, then to blue and so on down the chart. Take care not to confuse a lamp that emits high intensity visible blue light as superior to a lamp tuned more efficiently to emit true UV light.

UV LED TECHNOLOGY
 UV LED's produce only true and efficient UV Light. The CPS® UVPRO provides UV-A (Long wave UV) 325-375nm. Instant on LED provides the fastest leak inspection of any light available.
 Light spectrum wavelengths in nanometers

Why BLUE is NOT Necessarily Cool

A correctly tuned Ultra Violet (UV) lamp should predominantly emit invisible UV light waves with only a trace of visible "purple" or "blue" light. The small amount of visible light is required to direct the user's eyes to the leak search area, while the invisible UV light rays actually illuminate the leaking dye. Lamps that emit large amounts of visible blue light have been marketed heavily as being more powerful and more effective at fluorescing leaks, backed by the obvious high output of visible light. Knowing that UV dye additives requires invisible true UV light rays to effectively fluoresce dispels this claim altogether. In fact, special "blue blocking" glasses are required for use with these high output blue lamps in order to remove the nuisance blue light from the vision of the user during the leak search process. Otherwise, the high output of light will mask the actual leak or illuminating dye additive.

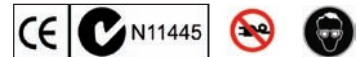

UVPRO True UV Inspection Lamp



UVPRO

The new and improved UVPRO light is the most compact and efficient UV light we have ever designed. The nine high intensity true UV LED's are specifically engineered to maximize the fluorescing capabilities of today's most commonly used dyes while greatly reducing the amount of "nuisance" background blue light emitted. Its rugged anodized aluminum body and o-ring sealed battery compartment allows it to handle harsh field conditions while small enough to conveniently fit in your pocket.

- 9 True UV emitting LED technology
- Rugged anodized aluminum body
- Works with all common dye additives
- Ultra Compact and lightweight
- Instant "ON" with no heat produced
- Operates on (3) AAA batteries (included)



AUTOMOTIVE

UV REFRIGERANT LEAK DETECTION

UV55A LED Refrigerant Leak Detection Kit



UV55A Includes: UVPRO LED flashlight, squeeze gun injector w/hose, R-134a 90 low side coupler, safety glasses, (5) UVS5 5-shot universal dye cartridges



UV55A

- UVPRO True UV emitting LED light technology
- Compact & Rugged anodized aluminum body
- Mess-free and easy to use Squeeze Gun™ injector
- 1 universal OEM approved dye cartridges; good for 5 vehicles
- Includes 90° low side snap coupler
- Operates 8 continuous hours on (3) AAA batteries (included)

UV Dichroic Refrigeration Leak Detection Kits



UV100

This design allows technician to use pre-measured, pre-filled dye cartridges and requires no refrigerant. Simply connect to low or high side and squeeze the trigger. Standard automotive a/c systems require only a 1/4oz/7.39ml. Larger cartridges are available for vans, trucks, buses, and refrigerated trailers.



Product application shown



UV300

This economical method of injection uses refrigerant to push dye into the system through a refillable anodized aluminum in-line injector. Simply fill the injector with the appropriate amount of universal Moonshine™ dye (1/4oz/ 7.39ml of dye treats 20oz/591ml lubricant).



Product application shown

UV Dichroic Filter Lamps



UVAL
Powerful 50W Bulb
Instant On Technology
90° Swivel Head
Use with UVXB (not included)

UVAM
Powerful 100W Bulb
Instant On Technology
45° Handle for Comfortable Grip
Use with UVXB (not included)

ACCESSORIES

UVXB	Rechargeable Battery Pack	UVXG	Safety/Enhancing Glasses
UVXBC	Battery Carrying Case	UVXLNS	50W Replacement Dichroic Lens
UVXC	100V Battery Charger	UVXLNS100	100W Replacement Dichroic Lens
UVXB100	50W Bulb - UVAL/UVCL	UVXSGA	Hose Assembly for Squeeze-Gun Injector
UVXBLB100	100W Bulb- UVAM/UVCL100	UVXSH	Hose Assembly for UVSTICK1
UVXBLBPRO	Replacement Bulb for UVPRO before 2007	UVXSHA	Hose Assembly for UVSTICK2 and Lo Coupler
UVXC	110V Battery Charger	UVXSTA	3/8" FM X LO side Auto Adapter for UVSTICK
UVXCE	220-240v Battery Charger		
UVXCN	Battery Connectors		



AUTOMOTIVE

UV REFRIGERANT LEAK DETECTION

Prefilled/Disposable Refrigerant Dye Capsules & Cartridges



UVS5 -
4 pk, 20 systems



UVS3 -
6 pk, 60 systems

- Prefilled, universal, disposable dye capsules
- Inject dye with refrigerant
- Drop-in, low cost replacements
- Interchangeable with Spectronic's capsule dye injection kits
- 6 Pk - 6 systems



UVS101



UV101A
R-134a 1/2" Acme



UV34DS

- 1/4oz / 7.5ml (12 per case)
- 1 vehicle per bottle
- Universal - works with PAG, Ester and mineral oils
- Controls inventory for service managers



UVCLNR
32oz./946ml. dye cleaner



UVUD6

- 8oz/237ml Universal dye bottles (6per case)
- Universal - works with PAG, Ester and mineral oils
- Lowest cost per application
- Excellent for large systems

Applications:

Automotive: 1/4oz / 7.5ml per vehicle (32 vehicles per bottle)
A/C&R: 1/4oz / 7.5ml per 20oz/591ml of systems lubricants.



all dyes include I.D. labels...



UVUDS

- 1oz/ 30ml Universal dye bottles (6 per case)
- Universal - works with PAG, Ester and mineral oils

Applications:

Automotive: 1/4oz / 7.5ml per vehicle (4 vehicles per bottle)

All MOONSHINE™ dye meets SAE J2297 standard. Spectronics™ & Tracer are all registered trademark of their respective companies

Squeeze Injectors - 1/4oz. / 7.5ml to 2oz. / 60ml Capacity

STEP 1: LOAD CARTRIDGE



STEP 2: ATTACH HOSE



STEP 3: CONNECT & INJECT



STEP 4: CLEAN PORT & DISCARD EMPTY CARTRIDGE



UVNJSA - Automotive Squeeze Gun with coupler (not shown)* cartridges sold separately

ITEM	QTY	DESCRIPTION
UVNJXOR	2	Replacement O-rings for UVNJ/UVNJ134/UVNJ1234
UVNJXO	2	Replacement O-rings for UVNJ2/ UVNJ34
UVXSH	1	Hose assembly for UVSTICK/ UVSTICK2
UVXSHA	1	Hose assembly for UVSTICK1/ UVSTICK2 w/ coupler
UVXSTA	1	3/8" FM x LO-side auto cplr adapter for UVSTICK

UVSTICK

Treats up to 175 lbs./79.38kg of refrigerant (one turn = 7 lbs./ 3.2kg of refrigerant (Automotive Dye Stick w/ R-134a coupler)
UVSTICK1 - A/C&R Dye Stick with 1/4" hose (no coupler)
UVSTICK - Replacement Dye Stick (not shown)



UVNJ1234
In-Line Automotive 1/4 to 1/2oz. - 7.5 to 14ml



UVNJ34
Hand Turn Automotive w/ R-134a Coupler In line
UVNJ2 - Hand Turn A/C&R w/ 1/4" Hose (not shown)
1/4 to 1/2oz. - 7.5 to 14ml



Oil Injectors TLJ2 / TLJ4
TLJ2 R-12 1/4" SAE Oil Dye Injector
TLJ4 R-134a 1/2" Acme Oil Dye Injector



AUTOMOTIVE

ELECTRICAL TEST & MEASURING INSTRUMENTS

TEMP-SEEKER® Four-Port Digital Thermometers



The **TM250A** is an excellent tool to diagnose compressor, condenser, and evaporator problems for today's automotive critical R-134a charged systems. Clamp on and air vent 15' probes allow for road testing problem vehicles. System temperature measurements up to 4 locations plus the optional humidity probe can be scanned for differential readings. A comprehensive R-134a automotive troubleshooting manual is included. **TM250A includes: (1) TMX2GA, (2) TMX2C, (1) TMX2FP** see pg.12 for additional probes

TM250A

TMX2C
CLAMP-ON PROBE
15ft/4.5m lead

TMX2FP
EVAPORATOR FLEX PROBE
15ft/4.5m lead

TMX2GA
GENERAL PURPOSE AIR PROBE
15ft/4.5m lead

Digital Multimeter



- Display: 4000 Counts
- Auto/Manual Range
- DC Voltage: 400mV/4/40/400V±0.5%, 600V ± 0.8%
- AC Voltage: 4/40/400V ± 0.8%, 400mV/600V ± 2%
- DC Current: 40/400mA ± 1.5%, 4/10A ± 2%
- AC Current: 40/400mA ± 2%, 4/10A ± 2.5%
- Resistance: 400Ω/4/40/400kΩ ± 1%, 4/40MΩ ± 2%
- Capacitance: 40nF/400nF/4μF /40μF ± 3%, 400μF /4000μF ± 20%
- Frequency: 10Hz -10MHz ± 0.1%
- Duty Cycle: 0.1%-99.9%±2%
- FI PEAK Voltages: 400V ± 5%
- O2 CROSS COUNT: 0 – 500Hz (per second)±0.5%
- RPM: 0 – 10000 RPM±0.5%
- Dwell Angle: 1 – 12 CYL±2%
- Pulse Width 1~999ms±2%
- Temperature: -50°C - 400°C ±0.75% ±3°C /-58°F - 752°F ±0.75% ±5°F

- Diode Check
- Continuity Buzzer
- Battery Test
- Auto Power Off (Can Disable)
- Relative Measurement
- Data Hold
- Data Recording: MAX/MIN

- ACCESSORIES:**
- Leads
 - Thermocouple Probe
 - Carrying Pouch
 - Replacement Parts: DMXTL (1000V Cat 3 Test Leads) and DMXF1 (Fuse Set)

DM400A Replacement Parts

DMXTL	1000V Cat 3 Test Leads
DMXF1	Fuse Set

DMA400





AUTOMOTIVE

RECOVERY, RECYCLING, RECHARGING EQUIPMENT

Nitrogen Pressure Leak Test Kit



NITROKIT automotive Air Conditioning Nitrogen Pressure Leak Test Kit. This kit is needed to pre-check automotive A/C systems for leaks due to loose mechanical connections, leaks in hoses, evaporators and condensers, before re-introducing refrigerant back into the A/C system. This will prevent unnecessary leakage of refrigerant into the atmosphere.

- The **NITROKIT** consists of the following items:
- NITRO test manifold with 0-200 PSIG gauge
 - 6' Red Service Hose with 1/4 SAE Female
 - R 134a High Side Snap Coupler
 - 25' Coiled Air Hose Assembly with 1/4 MPT X 1/4 Coupler
 - Instructional Manual



NITROKIT: includes the NITROKIT with a nitrogen regulator.



WARNING: Item must be used with nitrogen regulator. "NOT INCLUDED"

Portable R-134a Automotive Charging Station



CS12DMV5JP6Q

These portable, compact charging stations are ideal for small and large repair shops alike providing all the necessary tools to properly charge an A/C system on one lightweight tubular cart with rear wheels. Included with this station is a **PRO-SET** manifold, a **PRO-SET** vacuum pump, a **Compute-A-Charge** refrigerant scale, premium charging hoses and manual R-134a couplers. The unit is designed to allow a full system vacuum and charging without reconfiguring the hoses for a contamination free charging.

- Unsurpassed Charging Accuracy of $\pm 0.015\%$ of reading
- Hanging ports and hooks for hose storage
- Rear wheels on Frame for Ease of Mobility
- Perfect for Busy A/C shops or as Alternative to Large Charging Equipment
- All Components Store Easily on Cart

"Ideal for both new installations and existing service work."



Hard mounted manifolds



Rear wheels on Frame for Ease of Mobility



All Components Store Easily on Cart

Item	Application	Manifold Type	Refrig. Scales	Press./Temp Scales	Hoses	Vacuum Pump	Scale
CS12DMV4JP6Q	Automotive	Vortech 4 Valve (MV4J)	R22, R134A, R404A, R407C (80mm)	BAR/PSI °C	3-pk of 180cm Prem. Hoses & Cplrs.	Two Stage 45 l/m Pump (15 microns)	100kg Compute-A-Charge Scale
CS12DMV5JP6Q	Automotive	Vortech 5 Valve (MV5JD)	R22, R134A, R404A, R407C (80mm)	BAR/PSI °C	3-pk of 180cm Prem. Hoses & Cplrs.	Two Stage 45 l/m Pump (15 microns)	100kg Compute-A-Charge Scale
CS12DMV4LP6Q	Automotive	Vortech 4 Valve (MV4L)	R134a (Class 1)	BAR °C	3-pk of 180cm Prem. Hoses & Cplrs.	Two Stage 45 l/m Pump (15 microns)	100kg Compute-A-Charge Scale
CS12DMV5LP6Q	Automotive	Vortech 5 Valve (MV5LD)	R134a (Class 1)	BAR	3-pk of 180cm Prem. Hoses & Cplrs.	Two Stage 45 l/m Pump (15 microns)	100kg Compute-A-Charge Scale

cps[®]**AUTOMOTIVE****RECOVERY, RECYCLING,
RECHARGING EQUIPMENT****AR2788****Fully Compliant with the new EPA
required SAE J2788 Standard**

The heart of the AR2788 is the proprietary 1 HP CPS Cyclone™ oil less Hybrid compatible compressor providing up to 50% faster recovery cycle rates. A unique patent pending plumbing arrangement eliminates the use of all solenoid and check valves, both being highly susceptible to in-field failure when exposed to foreign contaminants such as aftermarket A/C Sealants. The patent pending flow control technology and 6 CFM PRO-SET® vacuum pump allows you to evacuate systems up to 50% faster. Intelligent self diagnostic capabilities, proprietary 5 level modular design layout and quality USA manufacturing all contribute to create a solid unit you can rely on to run smoothly in those busy summer months. As an added feature to the AR2788, all five modules are Takeapartable™ for ease in upgrades and maintenance.

EASY USER SET-UP & OPERATION

- No assembly required! Simply remove the packaging material and add refrigerant. Easy-to-follow instructional DVD and booklet included
- Multi language selectable in English, Spanish, French, German, and Chinese

ROCK SOLID CONSTRUCTION

- The AR2788 emulates the appearance of a professional grade mechanics tool box with all steel construction, high -gloss black enameled finish and chrome trimming
- Three integrated drawers provide convenient storage of a/c service tools and replacement filters
- Mobility around the shop floor is a breeze with heavy duty front casters and large rubber/tube tires in the rear

PROFIT FROM SPEED

- A critical component of the ARI J2788 standard states that a certified unit must be able to recover 95% of a 2007 Chevy Suburban's 3lb refrigerant charge (dual a/c) within 30 minutes. The AR2788 MACH 7 accomplished this task in less than 15 minutes! Earn greater return on your investment with **SPEED**
- Patent pending flow control technology enables faster and more accurate recovery, recycling and recharging





AUTOMOTIVE

**RECOVERY, RECYCLING,
RECHARGING EQUIPMENT**

AR2788

Integrated Drawers To Store Your A/C Tools



*Items shown in drawers not included

OIL-LESS COMPRESSOR TECHNOLOGY

- Powerful 1 HP oil-less Cyclone™ compressor provides up to 50% faster recovery cycle rates, ensures compatibility with all hybrid oils and is **MAINTENANCE FREE**

NO SOLENIODS or CHECK VALVES

- Exclusive patent pending plumbing arrangement eliminates the use of all solenoid and check valves, both prone to failure when exposed to foreign contaminants such as aftermarket A/C sealants

ZERO DOWNTIME WITH MODULAR DESIGN

- Advanced self-diagnostic software actively monitors all mechanical and electronic functions immediately notifying user of improper system operations
- The Takeapartable™ modular design enables “do-it-yourself” replacement of any affected module quickly and easily
- Full system diagnostics are available via our toll free customer service hotline
- Replacement modules are available for shipment **OVERNIGHT** for those customers located within the continental United States

OTHER FEATURES

- Battery back-up feature ensures the proper shut down of machine in the event of a power failure
- High performance two stage 6 CFM vacuum pump ensures deep, fast evacuation
- 8ft premium barrier service hoses & couplers
- Uses DOT or EU approved cylinders
- Automatic air purge
- Large 4.5 x 2.5 LCD display

Models	Tank Size
AR2788	50 lb
AR2788B	92 lb
AR2788E	40L EU

Optional Items	
Heater Blanket	AR27XHB115 (300W/115VAC) AR27XHB230 (300W/230VAC)
ARXC	Nylon Cover
AR27X H12	12ft. Service Hoses
AR27XH16	16ft. Service Hoses
AR27XH20	20ft. Service Hoses

Specifications	
Power	Convertible to either 115 or 230 VAC
Power Consumption	850W
Charging Accuracy	±.5oz (15 grams)
Recovery Accuracy	± 1oz (30 grams)
Pump Free Air Displacement	6 CFM (170 L/min)
Dimensions	2.5"/53cm wide x 25"/64cm deep x 48"/122cm high
Weight (w/o tank)	175lbs / 80 kgs
Filter Drier Size	41 cubic inches (Spare Filters: ARXF5)
Scale cap/resolution	100kg /2g
Access. Power Outlet	Rating 350W, 115VAC/230VAC



AUTOMOTIVE

RECOVERY, RECYCLING, RECHARGING EQUIPMENT

PRO-SET® Oil-Less Recovery / Recycling Unit

PRO-SET®



The **AR500EC** is a light weight portable recovery/recycling unit. It is perfect for small shops, agriculture, off road, tractor, and mobile service. It comes with hoses, coupler & with or without tank.

COMPRESSOR TYPE	1/3 hp reciprocating oil-less
RECOVERY RATE	.75 lbs. per minute vapor, 3lbs./min liquid
REFRIGERANT CLEARING OPERATION	manual self clearing valve
EVACUATION RATING*	28" hg. After self-evacuation open discharge valve to atmosphere while running the unit
OPERATING TEMP RANGE	32°F to 132°F
WEIGHT	24 lbs. (tank is additional weight)
WARRANTY	1 year parts and labor



ARXF2 - AR500 filter

Model	Power Supply	Gauges	Fittings
AR500EC	230 VAC 50/60Hz	BAR/kPa	1/4 SAE

AR500ECH = AR500EC + (2) 180cm BV Hose + Coupler



AR500EC

AR200 / AR300 / AR400 Series Accessories & Parts

P/N	Description	Model Used On
30-736	Low Side Manifold Gauge (psig/kgcm/kPa)	AR300, AR300A, AR212
30-737	High Side Manifold Gauge (psig/kgcm/kPa)	AR300, AR300A, AR212
30-738	Tank Pressure Gauge	All AR300/AR400
30-744	Low Side Manifold Gauge (BAR/kPa/psig)	AR300E, AR200E
30-745	High Side Manifold Gauge (BAR/kPa/psig)	AR300E, AR200E
30-733	Tank Pressure Gauge	AR212
ARH27-A1	R-134a Low Service Hose 1/2" ACME-14mm,8'	AR300, AR400
ARH28-A1	R-134a High Service Hose 1/2" ACME-14mm,8'	AR300, AR400
ARH6-A1	R-134a Low Service Hose 1/4 SAE-14mm,8'	AR300A, AR300E, AR400A
ARH7-A1	R-134a High Service Hose 1/4" SAE-14mm,8'	AR300A, AR300E, AR400A
ARH16-A1	R-12 Low Service Hose 1/4" SAE, 8'	AR212, AR400, AR400A
ARH17-A1	R-12 High Service Hose 1/4" SAE,8'	AR212, AR400, AR400A
ARXF	Filter Drier, 45 cubic inches	All AR200/300/400
M2XRK	Manifold Replacement valve	All AR200/300/400
74-017	Knob Label	All AR200/300/400
42-245	Knob	All AR200/300/400
AD12	1/2" ACME to R134a Refill Tank Adapter	All AR200/300/400
40-392	1/4" SAE to R134a Refill Tank Adapter	All AR200/300/400
QCL14	Premium Low Side Coupler 14mm	All R-134a models
QCH14	Premium High Side Coupler 14mm	All R-134a models



ARXC
Nylon Cover

Printer with cable & shelf



ARXP115 - 110 VAC
ARXP230 - 230 VAC



ARXF
AR212/300/400 filter



WARRANTY

CPS® guarantees that all products are free of manufacturing and material defects for one year from the date of purchase. If a product should fail during the guarantee period due to defective material or workmanship, it will be repaired or replaced (at our option) at no charge. This guarantee does not apply to products that have been altered, misused or are in need of field service maintenance. All repaired products will carry an independent 90 day warranty. LS3000 and LS790B carry a 2 year warranty.



CPS NORTH AMERICA

1010 East 31st Street, Hialeah, Florida 33013, USA
Tel: 305-687-4121, 1-800-277-3808, Fax: 305-687-3743
e-mail: cpssales@cpsproducts.com www.cpsproducts.com

CPS CANADA

4605 Crysler Ave. Niagara Falls, Ontario L2E 3V6
Tel: 905-358-3124, Fax - 905-358-7187, 1-866-629-3895,
e-mail: cpscanada@bellnet.ca

CPS PRODUCTS N.V

Krijgsbaan 241, 2070 Zwijndrecht, Belgium
Tel: (323) 281 30 40, Fax: (323) 281 65 83, www.cpsproducts.be,
e-mail: info@cpsproducts.be

CPS AUSTRALIA PTY. LTD.

109 Welland Avenue, Welland, South Australia 5007
Tel: +61 8 8340 7055, Fax: +61 8 8340 7033
e-mail: sales@cpsaustralia.com.au

CPS ASIA

56A Kallang Pudding Road #02-00 Singapore Road 349329
Tel: (65) 68461056, Fax: (65) 68461054
e-mail: cpsasia@singnet.com.sg



INDEX

30-733	PG 60	ARH6-A1	PG 60	AVC4B	PG 37	CR600ECH	PG 21
30-736	PG 60	ARH7-A1	PG 60	AVC4C	PG 37	CR700	PG 19,22
30-737	PG 60	ARXC	PG 59,60	AVC4CB	PG 37	CR700E	PG 20
30-738	PG 60	ARXF	PG 22,60	AVC4P	PG 37,48	CR700EC	PG 20
30-744	PG 60	ARXP115	PG 60	AVC4PB	PG 37	CR700ECH	PG 20
30-745	PG 60	ARXP230	PG 60	AVC4PS	PG 37	CR700JUK	PG 20
40-392	PG 60	AV2	PG 38	AVC4R	PG 37	CR700JUKCH	PG 20
41-631	PG 51	AV2B	PG 38	AVC4RB	PG 37	CRXCR1	PG 22
42-245	PG 60	AV2P	PG 38	AVC6C	PG 37	CRXCR2	PG 22
74-017	PG 60	AV2PB	PG 38	AVC6CB	PG 37	CRXCR3	PG 22
AB	PG 35	AV2R	PG 38	AVC6P	PG 37	CRXCR4	PG 22
AB12	PG 35,49	AV2RB	PG 38	AVC8BC	PG 37	CRXCR5	PG 22
AB3	PG 35	AV3	PG 38	AVC8C	PG 37	CRXCR6	PG 22
AB410	PG 35	AV3B	PG 38	AVCT12	PG 38	CRXCR7	PG 22
AB4103	PG 35	AV3R	PG 38	AVCT14	PG 38	CRXCR8	PG 22
AB41090A	PG 35	AV3RB	PG 38	AVCT18	PG 38	CRXF2	PG 22
AB410A	PG 35	AV4	PG 38	AVCT4	PG 38	CRXF3	PG 22
AB90	PG 35	AV4410	PG 38	AVCT4B	PG 38	CRXRM	PG 22
AB903	PG 35	AV4410B	PG 38	AVCT5	PG 38	CRXRM	PG 22
ABG18	PG 35	AV46M	PG 38	AVCT6	PG 38	CRXTOS2	PG 22
AC450	PG 10	AV46MB	PG 38	AVCT8	PG 38	CRXTOS3	PG 22
AC650	PG 10	AV4B	PG 38	AVCVAC	PG 18	CS12DMV1202J5E	PG 9
AD12	PG 36,50,60	AV4BU	PG 38	AVLP	PG 37	CS12DMV4HCP5E	PG 9
AD12B	PG 36	AV4L	PG 38	AVS1	PG 37	CS12DMV4JP5E	PG 9
AD14	PG 36,50	AV4LB	PG 38	AVS125	PG 37	CS12DMV4JP6Q	PG 57
AD149C	PG 36,50	AV4LR	PG 38	AVS1B	PG 37	CS12DMV4LP6Q	PG 57
AD14B	PG 36	AV4LRB	PG 38	AVS1BC	PG 37	CS12DMV5HCP5E	PG 9
AD18C	PG 36,50	AV4P	PG 38	AVS1V	PG 37,50	CS12DMV5J3P5E	PG 9
AD24	PG 36	AV4PB	PG 38	AVS2	PG 37	CS12DMV5JP5E	PG 9
AD24B	PG 36	AV4R	PG 38	AVS3	PG 37	CS12DMV5JP6Q	PG 57
AD36	PG 36	AV4RB	PG 38	AVS44	PG 38	CS12DMV5LP6Q	PG 57
AD369C	PG 36,50	AV5	PG 38	AVT2P	PG 38	CS12DMV5WS10Q	PG 9
AD36C	PG 36,50	AV5B	PG 38	AVT4	PG 38	CT206	PG 51
AD41	PG 36	AV5R	PG 38	AVT44	PG 38	CT305	PG 51
AD41B	PG 36	AV5RB	PG 38	AVT45	PG 16,38	CT499	PG 51
AD44	PG 36	AV6	PG 38	AVT48	PG 16,38	CT861	PG 51
AD44B	PG 36	AV6B	PG 38	AVT4B	PG 38	CT862	PG 51
AD47	PG 36	AV6MB	PG 38	AVT4M	PG 38	CT867	PG 51
AD47B	PG 36	AV6MM	PG 38	AVT4P	PG 38	CT884	PG 51
AD48	PG 36,50	AV6MR	PG 38	AVT64	PG 38	CTK1300A	PG 51
AD48B	PG 36	AV6MRB	PG 38	AVT64B	PG 38	CTK9100	PG 51
AD48C	PG 36	AV6R	PG 38	AVT87	PG 16,38	DM350	PG 11
AD61	PG 36	AV6RB	PG 38	BV	PG 35,49	DM450	PG 11
AD61B	PG 36	AVB34	PG 38	BV12	PG 49	DMA400	PG 56
AD68	PG 36	AVB346	PG 38	BV3	PG 35,49	DMXF1	PG 11,56
AD68V	PG 36	AVB346B	PG 38	BV38	PG 35,49	DMXF2	PG 11
AD78	PG 36	AVB346BU	PG 38	BV410	PG 35	DMXTL	PG 10,11,56
AD78B	PG 36	AVB346RB	PG 38	BV41018	PG 35	FS226	PG 41
AD81	PG 36	AVB34B	PG 38	BV4103	PG 35	FS226M	PG 41,52
AD81B	PG 36	AVB456	PG 38	BV41090A	PG 35	FS275	PG 41
AD84	PG 36	AVB456B	PG 38	BV410A	PG 35	FS275M	PG 41
AD849C	PG 36	AVB46	PG 38	BV45	PG 35	FSX501	PG 41
AD84B	PG 36	AVB46B	PG 38	BV453	PG 35	FSX502	PG 41
AD84C	PG 36	AVB6	PG 38	BV90	PG 35	FSX503	PG 41
AD87	PG 36	AVB6B	PG 38	BV903	PG 35	FSX504	PG 41
AD87S	PG 36	AVB6BC	PG 38	BVAD	PG 49	FSX505	PG 41
ADGM	PG 36,50	AVC134C	PG 37	BVAD12	PG 49	FSX506	PG 41
ADK12	PG 36	AVC134CB	PG 37	BVAD24	PG 49	FSX507	PG 41
ADK1234	PG 48	AVC134H	PG 37	BVAD38	PG 35	FSX508	PG 41
AM50	PG 15	AVC134H	PG 48	BVAD38	PG 49	FSX509	PG 41
AR200	PG 60	AVC134HB	PG 37	BVAD90	PG 49	FSX511	PG 41
AR2788	PG 58,59	AVC134L	PG 37	BVAD90	PG 49	FSX512	PG 41
AR2788B	PG 59	AVC134L	PG 48	BVBH	PG 35	FSX513	PG 41
AR2788E	PG 59	AVC134LB	PG 37	BVM	PG 35,49	FT195	PG 41
AR27X H12	PG 59	AVC134PS	PG 37	BVM3	PG 35	FT203	PG 41
AR27XH16	PG 59	AVC134PSB	PG 37	BVXH	PG 35	FT500	PG 41
AR27XH20	PG 59	AVC2	PG 37	BVXH	PG 49	FT500M	PG 41
AR27XHB115	PG 59	AVC3	PG 37	CC220	PG 7,9,22	FT525	PG 41
AR27XHB230	PG 59	AVC3P	PG 37	CC800A	PG 8	FT800FN	PG 41
AR300	PG 60	AVC3P	PG 48	CCLT	PG 8	FT806A	PG 41
AR400	PG 60	AVC3PB	PG 37	CCXHB	PG 7	FT806M	PG 41
AR500EC	PG 60	AVC4	PG 36,37	CCXHBV	PG 7	FTX500	PG 41
AR500ECH	PG 60	AVC410	PG 37	CR400EC	PG 21	FTX501	PG 41
ARH16-A1	PG 60	AVC410B	PG 37	CR400ECH	PG 21	FTX509	PG 41
ARH17-A1	PG 60	AVC410C	PG 37	CR500EC	PG 21	FTX510	PG 41
ARH27-A1	PG 60	AVC410CB	PG 37	CR500ECH	PG 21	FTX513	PG 41
ARH28-A1	PG 60	AVC425	PG 37	CR600EC	PG 21	FTX514	PG 41



INDEX

FTX515	PG 41	HP3RL	PG 33	HS6	PG 32	LSXC3	PG 2
FTX516	PG 41	HP3Y	PG 33	HS6A	PG 32	LSXE	PG 2
FTX517	PG 41	HP3YA	PG 33	HS6B	PG 32	LSXMK	PG 2
FTX518	PG 41	HP3YE	PG 33	HS6BA	PG 32	LSXS	PG 2
FTX800B410	PG 41	HP3YL	PG 33	HS6BE	PG 32	LSXS3	PG 2
FTX800BA	PG 41	HP5	PG 33	HS6BL	PG 32	LSXSF	PG 2
FTX800BM	PG 41	HP5A	PG 33	HS6E	PG 32	LSXSH	PG 2
FTX800R	PG 41	HP5B	PG 33	HS6L	PG 32	LSXVF	PG 2
FTX800Y	PG 41	HP5BA	PG 33	HS6R	PG 32	M2XHA	PG 28
GS30	PG 3	HP5BE	PG 33	HS6RA	PG 32	M2XRK	PG 28,60
GT1	PG 31	HP5BL	PG 33	HS6RE	PG 32	M4XHA	PG 28
GT2	PG 31	HP5E	PG 33	HS6RL	PG 32	M4XRK	PG 28
GT3	PG 31	HP5L	PG 33	HS6Y	PG 32	M5XRK	PG 28
HA10B	PG 48	HP5R	PG 33	HS6YA	PG 32	M6F	PG 28
HA10R	PG 48	HP5RA	PG 33	HS6YE	PG 32	M6FS3	PG 28
HA10Y	PG 48	HP5RE	PG 33	HS6YL	PG 32	M6FS5	PG 28
HA20B	PG 48	HP5RL	PG 33	HS8	PG 32	M6G	PG 28
HA20R	PG 48	HP5Y	PG 33	HS8A	PG 32	M6GS3	PG 28
HA20Y	PG 48	HP5YA	PG 33	HS8B	PG 32	M6GS5	PG 28
HA3	PG 48	HP5YE	PG 33	HS8BA	PG 32	M6O	PG 28
HA3A	PG 48	HP5YL	PG 33	HS8BE	PG 32	M6OS3	PG 28
HA3B	PG 48	HP6	PG 9,33	HS8BL	PG 32	M6OS5	PG 28
HA3R	PG 48	HP6A	PG 33	HS8E	PG 32	M6V	PG 28
HA3Y	PG 48	HP6B	PG 33	HS8L	PG 32	M6VS3	PG 28
HA3YA	PG 48	HP6BA	PG 33	HS8R	PG 32	M6VS5	PG 28
HA5	PG 48	HP6BE	PG 33	HS8RA	PG 32	MAF	PG 46
HA5A	PG 48	HP6BL	PG 33	HS8RE	PG 32	MAFA6K	PG 46
HA5B	PG 48	HP6E	PG 33	HS8RL	PG 32	MAFA8K	PG 46
HA5R	PG 48	HP6L	PG 33	HS8Y	PG 32	MAFA8KC	PG 46
HA5Y	PG 48	HP6R	PG 33	HS8YA	PG 32	MBD	PG 26
HA5YA	PG 48	HP6RA	PG 33	HS8YE	PG 32	MBF	PG 26
HA6	PG 48	HP6RE	PG 33	HS8YL	PG 32	MBFS3	PG 26
HA6A	PG 48	HP6RL	PG 33	HT134H	PG 48	MBFS5	PG 26
HA6B	PG 48	HP6Y	PG 33	HT134L	PG 48	MBG	PG 26
HA6R	PG 48	HP6YA	PG 33	HT1BE	PG 33	MBGS3	PG 26
HA6Y	PG 48	HP6YE	PG 33	HT1RE	PG 33	MBGS5	PG 26
HA6YA	PG 48	HP6YL	PG 33	HT1YE	PG 33	MBHC	PG 27
HA8	PG 48	HS10	PG 32	HT1YE	PG 33	MBHCP5E	PG 27
HA8B	PG 48	HS10B	PG 32	HT410BEJ	PG 33	MBO	PG 26
HA8R	PG 48	HS10R	PG 32	HT410EJ	PG 33	MBOS3	PG 26
HA8Y	PG 48	HS10Y	PG 32	HT410REJ	PG 33	MBOS5	PG 26
HC6	PG 48	HS3	PG 32	HT410YEJ	PG 33	MBV	PG 26
HC6B	PG 48	HS3A	PG 32	HTAD1	PG 48	MBVS3	PG 26
HC6R	PG 48	HS3B	PG 32	HTAD2	PG 48	MBVS5	PG 26
HC6Y	PG 48	HS3BA	PG 32	HTAD3	PG 48	MCO	PG 26
HHC2	PG 34	HS3BE	PG 32	HTBE	PG 33	MCOJ3	PG 26
HHC2S	PG 34	HS3BL	PG 32	HTE	PG 33	MCOJ5	PG 26
HHC3	PG 34	HS3E	PG 32	HTRE	PG 33	MDF	PG 47
HHC3S	PG 34	HS3L	PG 32	HTYE	PG 33	MDFS6K	PG 47
HHC4	PG 34	HS3R	PG 32	HV3	PG 34	MDFS8K	PG 47
HHC4S	PG 34	HS3RA	PG 32	HV5	PG 34	MDFS8KC	PG 47
HJ3	PG 33	HS3RE	PG 32	HV5E	PG 34	MMV2GS5	PG 24
HJ3B	PG 33	HS3RL	PG 32	HV6	PG 34	MMV2GS5C	PG 24
HJ3BE	PG 33	HS3Y	PG 32	HV8	PG 34	MV11A	PG 25
HJ3E	PG 33	HS3YA	PG 32	HX14R	PG 34,48	MV11AJ5	PG 25
HJ3R	PG 33	HS3YE	PG 32	HX38G	PG 34	MV11AJ5C	PG 25
HJ3RE	PG 33	HS3YL	PG 32	HX3D	PG 48	MV11AJ5E	PG 25
HJ3Y	PG 33	HS4	PG 32	HX3G	PG 34	MV11AJ5EC	PG 25
HJ5B	PG 33	HS4B	PG 32	HX4D	PG 48	MV11E	PG 25
HJ5BE	PG 33	HS4R	PG 32	HXD	PG 32,34,48	MV11EJ5	PG 25
HJ5E	PG 33	HS4Y	PG 32	HXG	PG 32,33,34,48	MV11EJ5C	PG 25
HJ5HJ3YE	PG 33	HS5	PG 32	HXG2	PG 33,34,48	MV11EJ5E	PG 25
HJ5R	PG 33	HS5A	PG 32	HXGA	PG 33,34,35	MV11EJ5EC	PG 25
HJ5RE	PG 33	HS5B	PG 32	HXGA410	PG 34	MV11O	PG 25
HJ5Y	PG 33	HS5BA	PG 32	HXGD	PG 34	MV11O2	PG 25
HJ5YE	PG 33	HS5BE	PG 32	HXGD2	PG 34	MV11O2J5	PG 25
HP3	PG 33	HS5BL	PG 32	HXKIT	PG 48	MV11O2J5C	PG 25
HP3A	PG 33	HS5E	PG 32	HXTG	PG 34	MV11O2J5E	PG 25
HP3B	PG 33	HS5L	PG 32	HXTG2	PG 33,34	MV11O2J5EC	PG 25
HP3BA	PG 33	HS5R	PG 32	LS3000B	PG 1,2	MV11O4	PG 25
HP3BE	PG 33	HS5RA	PG 32	LS780A	PG 2	MV11O4J5	PG 25
HP3BL	PG 33	HS5RE	PG 32	LS780B	PG 2	MV11O4J5C	PG 25
HP3E	PG 33	HS5RL	PG 32	LS790A	PG 2	MV11O4J5E	PG 25
HP3L	PG 33	HS5Y	PG 32	LS790B	PG 2	MV11O4J5EC	PG 25
HP3R	PG 33	HS5YA	PG 32	LSXB	PG 2	MV11OJ5	PG 25
HP3RA	PG 33	HS5YE	PG 32	LSXBMK	PG 2	MV11OJ5C	PG 25
HP3RE	PG 33	HS5YL	PG 32	LSXC	PG 2	MV11OJ5E	PG 25



INDEX

MV110J5EC	PG 25	MV2L	PG 24	MV4V	PG 24	MXMH	PG 28
MV12A	PG 25	MV2LS3	PG 24	MV4VS5	PG 24	MPXK	PG 28
MV12AJ5	PG 25	MV2LS3C	PG 24	MV4V5C	PG 24	MPXV	PG 28
MV12AJ5C	PG 25	MV2LS5	PG 24	MV4W	PG 24	MPXVO	PG 28
MV12AJ5E	PG 25	MV2LS5C	PG 24	MV4WS5	PG 24	NITROKIT	PG 57
MV12AJ5EC	PG 25	MV2N	PG 24	MV4WS5C	PG 24	NITROKITG	PG 57
MV12E	PG 25	MV2NS3	PG 24	MV4XRK	PG 28	QC134 SET	PG 49
MV12EJ5	PG 25	MV2NS3C	PG 24	MV5HC	PG 27	QC13490 SET	PG 49
MV12EJ5C	PG 25	MV2NS5	PG 24	MV5HC5PE	PG 27	QC14 SET	PG 49
MV12EJ5E	PG 25	MV2NS5C	PG 24	MV5HCD5PEC	PG 27	QC90 SET	PG 49
MV12EJ5EC	PG 25	MV2O	PG 24	MV5J	PG 24	QCH134	PG 49
MV12O	PG 25	MV2O2	PG 24	MV5J3	PG 24	QCH13490	PG 49
MV12O2	PG 25	MV2O2S3	PG 24	MV5J35PEC	PG 24	QCH14	PG 34,49,60
MV12O2J5	PG 25	MV2O2S3C	PG 24	MV5J35PECD	PG 24	QCH90	PG 49
MV12O2J5C	PG 25	MV2O2S5	PG 24	MV5J3D	PG 24	QCL134	PG 49
MV12O2J5E	PG 25	MV2O2S5C	PG 24	MV5J5PEC	PG 24	QCL13490	PG 49
MV12O2J5EC	PG 25	MV2OS3	PG 24	MV5J5PECD	PG 24	QCL14	PG 34,49,60
MV12O4	PG 25	MV2OS3C	PG 24	MV5JD	PG 9,24	QCL90	PG 49
MV12O4J5	PG 25	MV2OS5	PG 24	MV5K	PG 24	QCXO	PG 49
MV12O4J5C	PG 25	MV2OS5C	PG 24	MV5K5PEC	PG 24	QCXR34	PG 48
MV12O4J5E	PG 25	MV2Q	PG 24	MV5K5PECD	PG 24	QCXR34	PG 49
MV12O4J5EC	PG 25	MV2QS3	PG 24	MV5KD	PG 24	RG0H	PG 29
MV12OJ5	PG 25	MV2QS3C	PG 24	MV5L	PG 24	RG0L	PG 29
MV12OJ5C	PG 25	MV2QS5	PG 24	MV5L5PEC	PG 24	RGAH	PG 25,30
MV12OJ5E	PG 25	MV2QS5C	PG 24	MV5L5PECD	PG 24	RGAHB	PG 30
MV12OJ5EC	PG 25	MV2U	PG 24	MV5LD	PG 24	RGAL	PG 25,30
MV1FH	PG 24	MV2US3	PG 24	MV5N	PG 24	RGALB	PG 30
MV1FL	PG 24	MV2US3C	PG 24	MV5N5PEC	PG 24	RGEH	PG 25,30
MV1GH	PG 23,24	MV2US5	PG 24	MV5N5PECD	PG 24	RGEHB	PG 30
MV1GL	PG 24	MV2US5C	PG 24	MV5ND	PG 23,24	RGEL	PG 25,30
MV1J3H	PG 24	MV2V	PG 23,24	MV5Q	PG 24	RGELB	PG 30
MV1J3L	PG 24	MV2VS3	PG 24	MV5Q5PEC	PG 24	RGFH	PG 24,26,28,30,46,47
MV1JH	PG 24	MV2VS3C	PG 24	MV5Q5PECD	PG 24	RGFHB	PG 30,46,47
MV1JL	PG 24	MV2VS5	PG 24	MV5QD	PG 24	RGFL	PG 24,26,28,30,46,47
MV1KH	PG 24	MV2VS5C	PG 24	MV5U	PG 24	RGFLB	PG 30,46,47
MV1KL	PG 24	MV2W	PG 24	MV5U5PEC	PG 24	RGGH	PG 24,26,28,30
MV1LH	PG 24	MV2WS3	PG 24	MV5U5PECD	PG 24	RGHGB	PG 30
MV1LL	PG 24	MV2WS3C	PG 24	MV5UD	PG 24	RGGL	PG 24,26,28,30
MV1NH	PG 24	MV2WS5	PG 24	MV5W	PG 24	RGGLB	PG 30
MV1NL	PG 24	MV2WS5C	PG 24	MV5W5PEC	PG 24	RGHCH	PG 30
MV1O2H	PG 24	MV2XRK	PG 28	MV5W5PECD	PG 24	RGHCHB	PG 30
MV1O2L	PG 24	MV4F	PG 24	MV5WD	PG 24	RGHCL	PG 30
MV1OH	PG 24	MV4FS5	PG 24	MV5XRK	PG 28	RGHCLB	PG 30
MV1OL	PG 24	MV4FS5C	PG 24	MV7F	PG 46	RGHGB	PG 29
MV1QH	PG 24	MV4G	PG 24	MV7FA6Q	PG 46	RGHLB	PG 29
MV1QL	PG 24	MV4GS5	PG 24	MV7FA6QC	PG 46	RGJ3H	PG 24,29,30
MV1UH	PG 24	MV4GS5C	PG 24	MV7FA8Q	PG 46	RGJ3HB	PG 30
MV1UL	PG 24	MV4HC	PG 27	MV7FA8QC	PG 46	RGJ3L	PG 24,29,30
MV1VH	PG 24	MV4HC5PE	PG 27	MV7J	PG 46	RGJ3LB	PG 30
MV1VL	PG 24	MV4HC5PEC	PG 27	MV7JA6Q	PG 46	RGJH	PG 24,30,46,47
MV1WH	PG 24	MV4J	PG 23,24	MV7JA6QC	PG 46	RGJHB	PG 30,46,47
MV1WL	PG 24	MV4J3	PG 24	MV7JA8Q	PG 46	RGJL	PG 24,30,46,47
MV2F	PG 24	MV4J3S5	PG 24	MV7JA8QC	PG 46	RGJLB	PG 30,46,47
MV2FS3	PG 24	MV4J3S5C	PG 24	MV7L	PG 46	RGKH	PG 24,29,30
MV2FS3C	PG 24	MV4JS5	PG 24	MV7LA6Q	PG 46	RGKHB	PG 30
MV2FS5	PG 24	MV4JS5C	PG 24	MV7LA6QC	PG 46	RGKL	PG 24,29,30
MV2FS5C	PG 24	MV4K	PG 24	MV7LA8Q	PG 46	RGKLB	PG 30
MV2G	PG 24	MV4KS5	PG 24	MV7LA8QC	PG 46	RGLH	PG 30,46,47
MV2GS3	PG 24	MV4KS5C	PG 24	MV8F	PG 47	RGLHB	PG 30,46,47
MV2GS3C	PG 24	MV4L	PG 24	MV8FA6Q	PG 47	RGLL	PG 30,46,47
MV2HC	PG 27	MV4LS5	PG 24	MV8FA6QC	PG 47	RGLLB	PG 30,46,47
MV2HCP5E	PG 27	MV4LS5C	PG 24	MV8FA8Q	PG 47	RGNH	PG 24,30
MV2J	PG 24	MV4N	PG 24	MV8FA8QC	PG 47	RGNHB	PG 30
MV2J3	PG 24	MV4NS5	PG 24	MV8J	PG 47	RGNL	PG 24,30
MV2J3S3	PG 24	MV4NS5C	PG 24	MV8JA6Q	PG 47	RGNLB	PG 30
MV2J3S3C	PG 24	MV4O	PG 24	MV8JA6QC	PG 47	RG02H	PG 24,25,30
MV2J3S5	PG 24	MV4O2	PG 24	MV8JA8Q	PG 47	RG02HB	PG 30
MV2J3S5C	PG 24	MV4O2S5	PG 24	MV8JA8QC	PG 47	RG02L	PG 24,25,30
MV2JS3	PG 24	MV4O2S5C	PG 24	MV8L	PG 47	RG02LB	PG 30
MV2JS3C	PG 24	MV4OS5	PG 24	MV8LA6Q	PG 47	RG04H	PG 25,30
MV2JS5	PG 24	MV4OS5C	PG 24	MV8LA6QC	PG 47	RG04HB	PG 30
MV2JS5C	PG 24	MV4Q	PG 24	MV8LA8Q	PG 47	RG04L	PG 25,30
MV2K	PG 24	MV4QS5	PG 24	MV8LA8QC	PG 47	RG04LB	PG 30
MV2KS3	PG 24	MV4QS5C	PG 24	MVXK	PG 28	RG0H	PG 24,25,26,28,30
MV2KS3C	PG 24	MV4U	PG 24	MXBK	PG 28	RG0HB	PG 30
MV2KS5	PG 24	MV4US5	PG 24	MXC	PG 28	RGOL	PG 24,25,26,28,30
MV2KS5C	PG 24	MV4US5C	PG 24	MXK	PG 28	RGOLB	PG 30



INDEX

RGQH	PG 24,30	TCX4RS	PG 39	TLSWO	PG 43	UVNJS	PG 6
RGQHB	PG 30	TCX4S	PG 39	TLSWS	PG 43	UVNJSА	PG 55
RGQL	PG 24,30	TCX6CTS	PG 39	TLSWT	PG 43	UVNJXO	PG 55
RGQLB	PG 30	TCX7C	PG 39	TLTWSM	PG 42	UVNJXOR	PG 55
RGUH	PG 24,30	TCX7CS	PG 39	TLVC	PG 37,50	UVPRO	PG 4
RGUHB	PG 30	TCX7CTS	PG 39	TLVC1	PG 37,50	UVPRO	PG 53
RGUL	PG 24,30	TCX7S	PG 39	TLVC134	PG 37,50	UVS1	PG 6
RGULB	PG 30	TL7238	PG 52	TLVC2	PG 37,50	UVS101	PG 55
RGVH	PG 24,26,28,30	TL7239	PG 52	TLVC2B	PG 37	UVS101	PG 6
RGVHB	PG 30	TL7240	PG 52	TLVC4	PG 37,50	UVS2	PG 6
RGVL	PG 24,26,28,30	TL7241	PG 52	TLVC410	PG 37	UVS3	PG 6,55
RGVLB	PG 30	TL7242	PG 52	TLVC6	PG 37,50	UVS5	PG 55
RGWH	PG 24,30	TL7881	PG 52	TLVC810	PG 37,50	UVSTICK	PG 55
RGWHB	PG 30	TLCT12	PG 50	TLVCS	PG 37	UVSTICK1	PG 55
RGWL	PG 24,30	TLCT1234	PG 50	TLVCS410	PG 37	UVUD6	PG 6,55
RGWLB	PG 30	TLCT34	PG 50	TLWA06	PG 45	UVUDS	PG 6,55
RGX68BB	PG 29	TLCTX34	PG 50	TLWA08	PG 45	UVXB	PG 5,54
RGX68RB	PG 29	TLCTXG	PG 50	TLWA10	PG 45	UVXBC	PG 5,54
RGX80BB	PG 29	TLDB	PG 42	TLWA12	PG 45	UVXBLB	PG 5,54
RGX80RB	PG 29	TLDB2	PG 42	TLWL53A	PG 45	UVXBLB100	PG 5,54
RM	PG 3	TLDB34	PG 52	TLXMIR1	PG 44	UVXBLBPRO	PG 5,54
RM12	PG 3	TLDKRH	PG 45	TLXMIR2	PG 44	UVXC	PG 5,54
RM134	PG 3	TLDKWH	PG 45	TLXMIR3	PG 44	UVXCE	PG 5,54
RM404	PG 3	TLE6	PG 42	TLXMIR4	PG 44	UVXCN	PG 5,54
RM407	PG 3	TLE601	PG 42	TLXVC410BC	PG 37	UVXG	PG 5,54
RM410	PG 3	TLE6M	PG 42	TLXVC410RT	PG 37	UVXLNS	PG 5,54
RM502	PG 3	TLFC1	PG 44	TLXVCBC	PG 37	UVXLNS100	PG 5,54
RM507	PG 3	TLFC2	PG 44	TLXVCRT	PG 37	UVXSGA	PG 5,54
RMX11	PG 3	TLFC6	PG 44	TLXVCT	PG 37	UVXSH	PG 5,54,55
SM150	PG 15	TLFG	PG 52	TM250	PG 12	UVXSHA	PG 5,54,55
T40L	PG 22	TLFGXT	PG 52	TM250A	PG 56	UVXSTA	PG 5,54,55
TB04	PG 40	TLH06	PG 42	TM250C	PG 12	VCT10	PG 38
TB04	PG 40	TLH08	PG 42	TM50	PG 13	VG100A	PG 16
TB05	PG 40	TLH10	PG 42	TMAP	PG 13	VG200	PG 16
TB06	PG 40	TLH12	PG 42	TMAPC	PG 13	VG201	PG 16
TB08	PG 40	TLH14	PG 42	TMDP	PG 13	VGXC	PG 16
TB10	PG 40	TLH16	PG 42	TMIINI12	PG 13,14	VGXH	PG 16
TB10MM	PG 40	TLH18	PG 42	TMX2A	PG 12	VP10D	PG 17
TB10XH	PG 40	TLH22	PG 42	TMX2C	PG 12	VP12D	PG 17
TB12	PG 40	TLH26	PG 42	TMX2C	PG 56	VP2D	PG 9,17
TB12MM	PG 40	TLHM10	PG 42	TMX2FP	PG 12	VP2S	PG 17
TB12XH	PG 40	TLHM12	PG 42	TMX2FP	PG 56	VP3D	PG 17
TB14	PG 40	TLHM15	PG 42	TMX2G	PG 12	VP3S	PG 17
TB15MM	PG 40	TLHM16	PG 42	TMX2GA	PG 12	VP6D	PG 17
TB16MM	PG 40	TLHM18	PG 42	TMX2GA	PG 56	VP6S	PG 17
TB250	PG 40	TLHM20	PG 42	TMX2P	PG 12	VP8D	PG 17
TB368	PG 40	TLHM22	PG 42	TMX2RH	PG 12	VPAS4	PG 18
TB6MM	PG 40	TLHM28	PG 42	TMX2S	PG 12	VPAS8	PG 18
TBS04	PG 40	TLHM35	PG 42	TMX2P	PG 14	VPASU	PG 18
TBS05	PG 40	TLHM42	PG 42	TMXSK	PG 14	VPOG 6	PG 18
TBS06	PG 40	TLJ2	PG 6,55	TMXSK90	PG 14	VPOP 12	PG 18
TBS08	PG 40	TLJ4	PG 6,55	UV1	PG 6	VPOQ 12	PG 18
TBS10	PG 40	TLK134	PG 51	UV100	PG 54	VPXB2	PG 18
TBS12	PG 40	TLMAG1	PG 44	UV101	PG 6	VPXB3	PG 18
TBX2	PG 40	TLMIR1	PG 44	UV101A	PG 55	VPXC100	PG 18
TBXB1	PG 40	TLMIR2	PG 44	UV150	PG 5	VPXCS2	PG 18
TBXM10	PG 40	TLMIR3	PG 44	UV152	PG 5	VPXCS3	PG 18
TBXM14	PG 40	TLMIR4	PG 44	UV152UN	PG 5	VPXEB2	PG 18
TBXM16	PG 40	TLMKC18	PG 44	UV2	PG 6	VPXEB3	PG 18
TBXM19	PG 40	TLMSP	PG 43	UV200	PG 5	VPXEB02	PG 18
TBXM22	PG 40	TLOT12	PG 51	UV250	PG 5	VPXEB03	PG 18
TBXM6	PG 40	TLOT18	PG 51	UV252	PG 5	VPXEH	PG 18
TBXM8	PG 40	TLOT19	PG 51	UV3	PG 6	VPXEP1	PG 18
TBXR	PG 40	TLOTK	PG 51	UV300	PG 54	VPXEP2	PG 18
TC100	PG 39	TLPK	PG 43	UV34DS	PG 55	VPXF15	PG 18
TC127	PG 39	TLPO	PG 43	UV55	PG 5	VPXFB2	PG 18
TC174	PG 39	TLPORR	PG 43	UV55A	PG 54	VPXFB3	PG 18
TC206	PG 39	TLPP	PG 43	UVAL	PG 54	VPXFG2	PG 18
TC274	PG 39,40	TLPPX	PG 43	UVAM	PG 54	VPXH	PG 18
TC312	PG 39	TLRAD	PG 52	UVCL	PG 5	VPXIP2	PG 18
TCAP	PG 39	TLREF	PG 52	UVCL100	PG 5	VPXIP3	PG 18
TCSET	PG 39	TLRK	PG 48	UVCLNR	PG 55	VPXJ220	PG 17
TCX100CS	PG 39	TLSD1	PG 43	UVCLNR	PG 6	VPXODP	PG 18
TCX4C	PG 39	TLSWB	PG 43	UVNJ	PG 6	VPXOEP	PG 18
TCX4CS	PG 39	TLSWH	PG 43	UVNJ1234	PG 55	VPXOL2	PG 18
TCX4CTS	PG 39	TLSWHM	PG 43	UVNJ2	PG 55	VPXOL3	PG 18
TCX4R	PG 39	TLSWL	PG 43	UVNJ34	PG 55	VPXOMP	PG 17

cps®

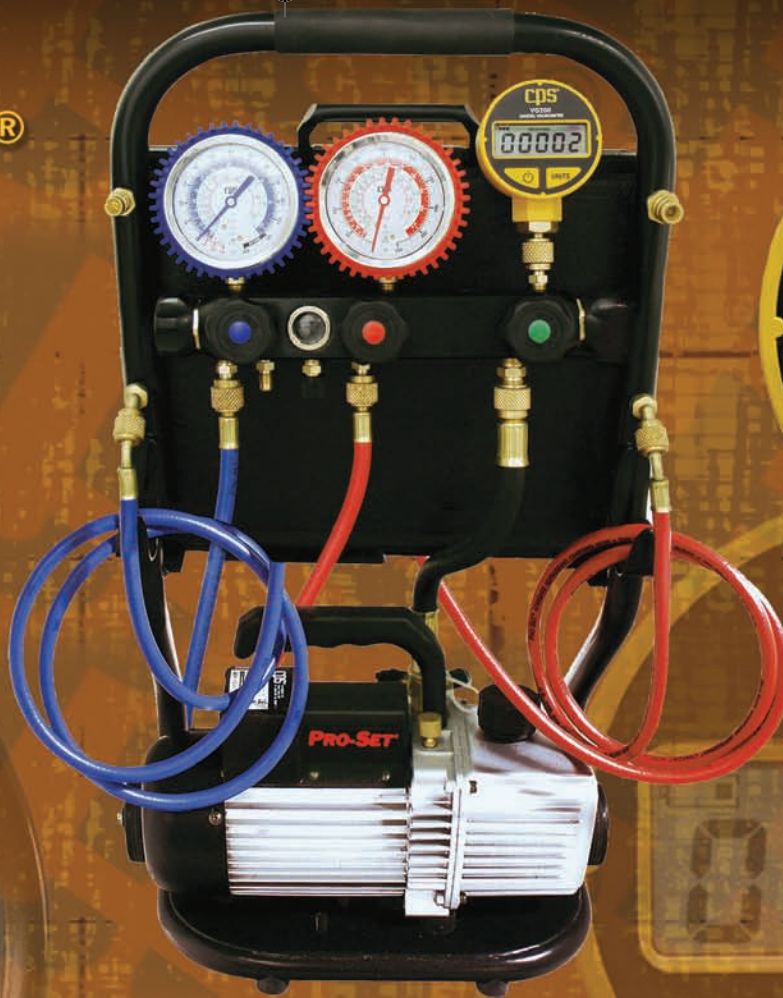

GLOBAL HEADQUARTERS
1010 East 31st Street, Hialeah, Florida 33013, USA
Tel: 305-687-4121, 1-800-277-3808, Fax: 305-687-3743
e-mail: cpssales@cpsproducts.com www.cpsproducts.com

CPS CANADA
4605 Chrysler Ave. Niagara Falls, Ontario L2E 3V6
Tel: 905-358-3124, Fax - 905-358-7187, 1-866-629-3895,
e-mail: cpscanada@bellnet.ca

CPS PRODUCTS N.V
Krijgsbaan 241, 2070 Zwijndrecht, Belgium
Tel: (323) 281 30 40, Fax: (323) 281 65 83, www.cpsproducts.be,
e-mail: info@cpsproducts.be

CPS AUSTRALIA PTY. LTD.
109 Welland Avenue, Welland, South Australia 5007
Tel: +61 8 8340 7055, Fax: +61 8 8340 7033
e-mail: sales@cpsaustralia.com.au

CPS ASIA
56A Kallang Pudding Road #02-00 Singapore Road 349329
Tel: (65) 68461056, Fax: (65) 68461054
e-mail: cpsasia@singnet.com.sg

LTVN2008

